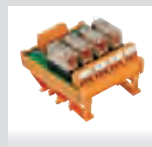

The RS-SERIES product line**RS 30**

Relay modules with 1 NO or
1 CO contact

**RSM**

4-, 8-, 16-times multi-interfaces

**RS 31**

Relay modules with 1 power contact

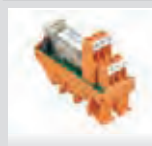
**RS 32**

Relay modules with 2 CO contacts

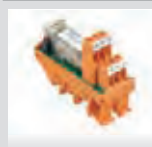
**RS32**

Relay modules with 2 positively-driven
CO contacts

**RSO 30**

Opto modules

RS-SERIES – Relay modules

**1 NCC, 1 NOC
or 1 change-over contact**

RS 30

Screw connection

1 NOC
1 NCC



1 change-over contact



RS 30

Isolating plug with screw connection

1 NOC
1 NCC



1 change-over contact



Technical data

Input voltage	5...60 V ± 10 %; 115 V/230 V + 5 % – 15 %
Nominal consumption – (W)	–
Nominal consumption ~ (VA)	–
Drop-out current of relay module (at 20 °C)	–
Drop-out current of relay module (at 20 °C)	–
Pick-up current	–
Output voltage max.	250 V
Continuous current	5 A

Derating curve
 a = fitted on mounting rail in horizontal row without spacing
 b = fitted on mounting rail in horizontal row with 20 mm spacing



5 VTTL	12 V–	24 V–	24 V=	48 V–	115 V–	230 V–
0.45 W ¹⁾	0.45 W	0.45 W	0.45 W	0.45 W	–	–
–	–	–	0.7 VA	–	0.8 VA	0.8 VA
–	3 mA	3 mA	2.5 mA–	2 mA	–	–
–	–	–	3.5 mA–	–	1 mA–	1 mA–
–	–	12 mA	–	10 mA	6 mA	–
250 V	250 V	250 V	250 V	250 V	250 V	250 V
5 A	6 A	6 A	6 A	6 A	5 A	3 A

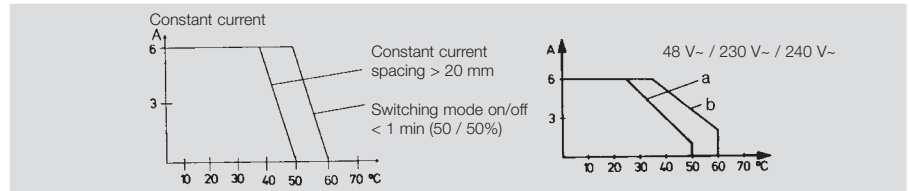

Making current	8 A
Making power under ohmic load	2000 VA / 100 W
Min. switching power/switching current	250 mW / 10 mA
Duration of bounce	≤ 3 ms
Typical switching times	
– Pick-up delay	≤ 8 ms
– Drop-out delay	≤ 7 ms
Max. switching frequency	70 Hz
Contact material	AgNi, gold-flashed
Service life, mechanical	>10 ⁷ switching cycles
– 24 V-, 1A ohmic load	> 5 x 10 ⁶ switching cycles
– 230 V-, 3A, ohmic load	>7 x 10 ⁵ switching cycles
Storage temperature	–40 °C...+60 °C
Ambient temperature, fitted on mounting rail	
– in horizontal row without spacing	–25 °C...+40 °C
– in horizontal row without spacing ≥ 20 mm spacing	–25 °C...+50 °C
Humidity	40 °C/93 rel. humidity, no condensation

Insulation coordination to EN 50178	
Surge category	III
Pollution severity	2

Dimensions	
Mounting width	11.2 mm NOC / NCC, 25 mm change-over contact
Length (at 90° to mounting rail)	70 mm (74 mm BL/SL version)
Height (with TS 32 / TS 35 x 7.5)	56 mm / 51.5 mm

8 A						
2000 VA / 100 W						
250 mW / 10 mA						
≤ 3 ms						

≤ 8 ms	≤ 8 ms	≤ 8 ms	≤ 8 ms	≤ 12 ms	≤ 9 ms	≤ 10 ms
≤ 7 ms	≤ 7 ms	≤ 7 ms	≤ 16 ms	≤ 11 ms	≤ 8 ms	≤ 9 ms
70 Hz	70 Hz	70 Hz	30 Hz	70 Hz	30 Hz	30 Hz

AgNi, gold-flashed						
>10 ⁷ switching cycles						
> 5 x 10 ⁶ switching cycles						
>7 x 10 ⁵ switching cycles						
–40 °C...+60 °C						

–25 °C...+40 °C						
–25 °C...+50 °C						
40 °C/93 rel. humidity, no condensation						

III						
2						

11.2 mm NOC / NCC, 25 mm change-over contact						
70 mm (74 mm BL/SL version)						
56 mm / 51.5 mm						

¹⁾ Rated consumption of auxiliary voltage 24 V–.

RS 30

Screw connection

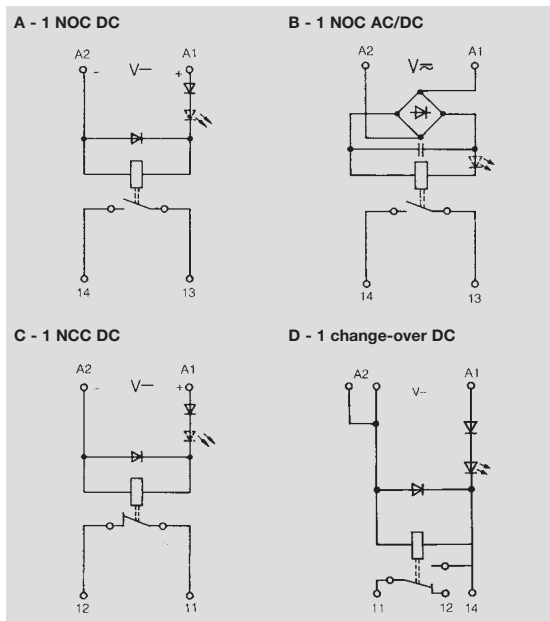

RS 30

Isolating plug with screw connection

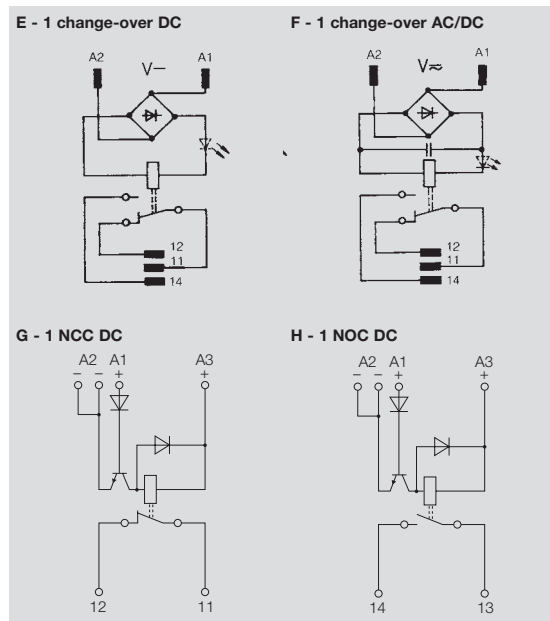

Ordering data

Wiring diagram	
Input voltage	Function indicator
5 V-, TTL	without
12 V-	without LED red
24 V-	without LED green LED red
24 V=	without LED green LED red
48 V-	without LED green LED red
115 V-	without LED green LED red
230 V-	without LED green LED red

A	B	C	D
NOC	NOC	NCC	change-over
1129421001		1129521001	
1101661001		1100961001	
1101611001		1100911001	1181511001
1101621001		1100921001	1181521001
	1101711001		
	1101721001		
1101811001			
1101821001			
	1102111001		
	1102121001		
	1102261001		
	1102211001		
	1102221001		

E	F	G	H
change-over	change-over	NCC	NOC
		1167660000	1167760000
	1129660000		
1100260000			
1100210000			
1100220000			
	1100360000		
1100410000			
1100420000			
	1100760000		
	1100860000		

RS SERIES - RS 31 - Relay modules

**1 CO contact
AC/DC coil**

- For high switching capacities
- Suitable for switching inductive loads



B

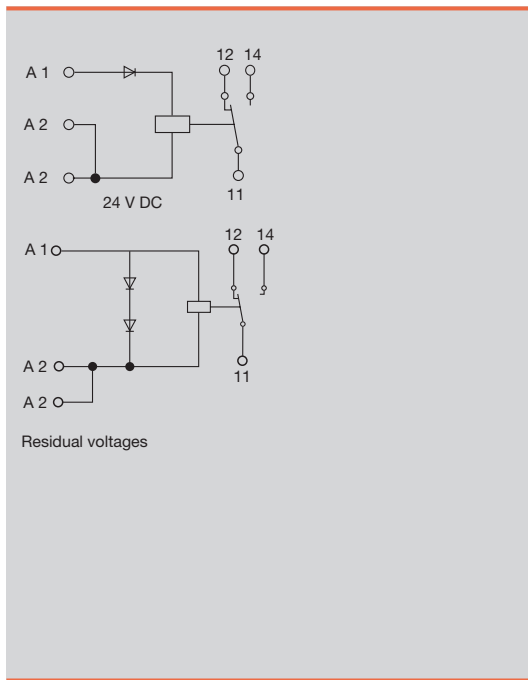

Output	
Switching voltage AC, max. / Continuous current	250 V / 16 A
min. switching capacity	1 W
Sparkover time / Drop-out time	9 ms / 10 ms
Contact material	AgCdO
Mechanical service life	30*10 ⁶ switching cycles
Max. switching frequency at rated load	0.1 Hz
Rated data	
Status indicator / Free-wheel diode	red LED / Yes
Reverse polarity protection	Available
Ambient temperature (operational)	-25 °C...+40 °C
Storage temperature	-40 °C...+60 °C
Humidity	40°C / 93% rel. humidity, no condensation
Approvals	GOSTME25; CE
Insulation coordination (EN 50 178)	
Standards	EN 50178
Rated voltage	250 V
Impulse withstand voltage	6 kV
Clearance and creepage distances for control/load side	> 3 mm
Overvoltage category	III
Pollution severity	2
Protective separation acc. to VDE 0106 part 101	No
Dimensions	
Clamping range (nominal / min. / max.)	mm ² 2.5 / 0.5 / 4
Length x width x height	mm 70 / 25 / 53.5
Screw connection	
Note	

Ordering data

Input	24 V DC 1CO	115 V AC 1CO	230 V AC 1CO
Rated control voltage	24 V DC ±10 %	115 V AC +5 % / -15 %	230 V AC +5 % / -15 %
Rated current AC		8 mA	4.5 mA
Rated current DC	40 mA		
Power rating	1 W	1 VA	1 VA
AC Response/dropout Volt		98 V	195 V
DC Response/dropout Volt	21.5V		
AC pickup/dropout current		-/1.5mA	-/2.2mA
DC pickup/dropout current	-/11.5mA		

Ordering data	24 V DC 1CO	115 V AC 1CO	230 V AC 1CO
Type	RS 31 24VDC LD LP 1U	RS 31 115VAC LD LP 1U	RS 31 230VAC LD LP 1U
Order No.	1128361001	1150461001	1128461001
Type			
Order No.			
Ordering data			
Note			



**2 CO contacts
positively-driven contacts**

- DC coil
- Relay coupler with 2 positively-driven CO contacts, acc. to EN 50205
- 2-pole safety relay modules with 2 CO contacts *)
- For mounting on TS 32/35



B

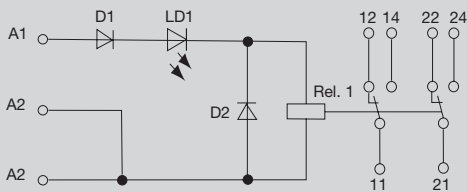

Output	
Switching voltage AC, max. / Continuous current	250 V / 4 A
min. switching capacity	5 V / 10 mA
Sparkover time / Drop-out time	13 ms / 10 ms
Contact material	AgNi 90/10
Mechanical service life	20*10 ⁶ switching cycles
Max. switching frequency at rated load	0.1 Hz
Rated data	
Status indicator / Free-wheel diode	red LED / No
Reverse polarity protection	Yes
Ambient temperature (operational)	-25 °C...+40 °C
Storage temperature	-40 °C...+85 °C
Humidity	40°C / 93% rel. humidity, no condensation
Approvals	CE
Insulation coordination (EN 50 178)	
Standards	EN 50178
Rated voltage	300 V
Impulse withstand voltage	4 kV
Clearance and creepage distances for control/load side	≥ 4 mm
Overtolerance category	III
Pollution severity	2
Protective separation acc. to VDE 0106 part 101	No
Dimensions	
Clamping range (nominal / min. / max.)	mm ² 2.5 / 0.5 / 4
Length x width x height	mm 70 / 25 / 63.5
Screw connection	
*) According to EN50205, only 1 NO / 1 NC is permitted for safety circuits	

Ordering data

24 V DC 2CO

Input	
Rated control voltage	24 V DC ±10 %
Rated current AC	
Rated current DC	21 mA
Power rating	0.5 W
AC Response/dropout Volt	
DC Response/dropout Volt	16 V / 10 V
AC pickup/dropout current	
DC pickup/dropout current	12.5 mA / 7mA

Ordering data	
Type	RS32 24 VDC SAFETY
Order No.	8872160000
Type	
Order No.	

Ordering data	

Note	

RS SERIES - RS 32 - Relay modules

2 CO contacts

DC coil

- Relay coupler with two CO contacts
- Relay module soldered
- Optional multi-voltage input
- For mounting on TS 32/35



B

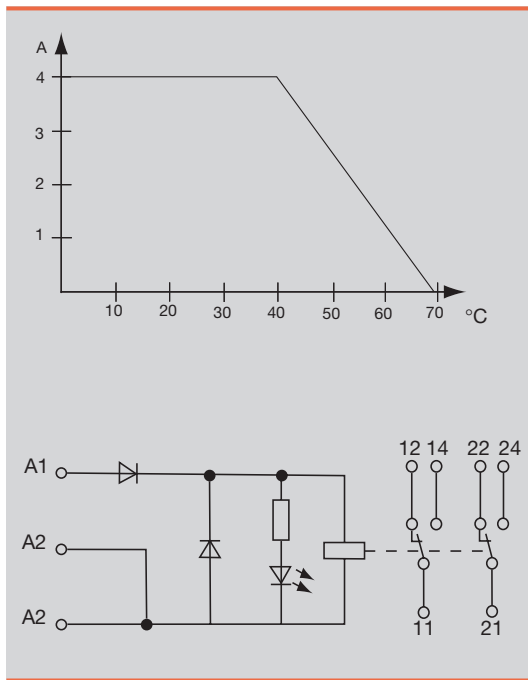

Output	
Switching voltage AC, max. / Continuous current	250 V / 4 A
min. switching capacity	10 V / 10 mA
Sparkover time / Drop-out time	13 ms / 10 ms
Contact material	AgNi 90/10
Mechanical service life	30*10 ⁶ switching cycles
Max. switching frequency at rated load	0.1 Hz
Rated data	
Status indicator / Free-wheel diode	red LED / No
Reverse polarity protection	Available
Ambient temperature (operational)	-25 °C...+40 °C
Storage temperature	-40 °C...+60 °C
Humidity	40°C / 93% rel. humidity, no condensation
Approvals	GOSTME25; CE
Insulation coordination (EN 50 178)	
Standards	EN 50178
Rated voltage	250 V
Impulse withstand voltage	4 kV
Clearance and creepage distances for control/load side	> 3 mm
Overtoltage category	III
Pollution severity	2
Protective separation acc. to VDE 0106 part 101	No
Dimensions	
Clamping range (nominal / min. / max.)	mm ² 2.5 / 0.5 / 4
Length x width x height	mm 70 / 25 / 63.5
Note	

Ordering data

Input		24 V DC 2CO
Rated control voltage		24 V DC ±10 %
Rated current AC		
Rated current DC		25 mA
Power rating		0.6 W
AC Response/dropout Volt		
DC Response/dropout Volt		21.5V
AC pickup/dropout current		
DC pickup/dropout current		-/5 mA

Ordering data	
Type	RS 32 24VDC LD LP 2U
Order No.	9406121001
Type	
Order No.	

Ordering data	
Type	
Order No.	

Note	



2 CO contacts
UC coil



B

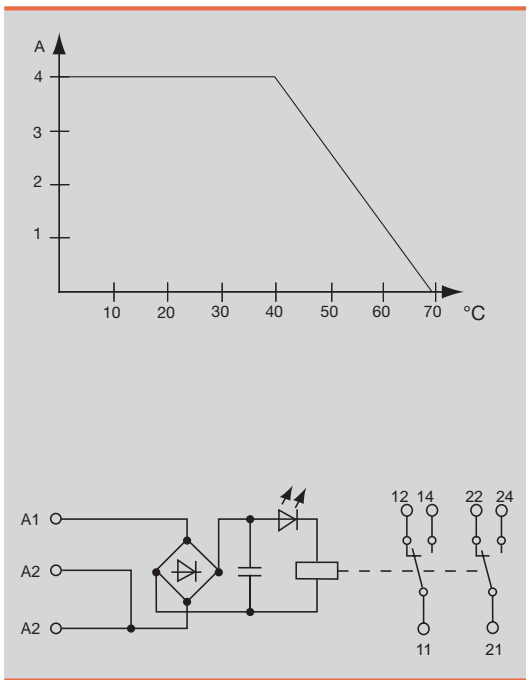

Output	
Switching voltage AC, max. / Continuous current	250 V / 4 A
min. switching capacity	12 V / 10 mA
Sparkover time / Drop-out time	13 ms / 10 ms
Contact material	AgNi 90/10
Mechanical service life	30*10 ⁶ switching cycles
Max. switching frequency at rated load	0.1 Hz
Rated data	
Status indicator / Free-wheel diode	red LED / No
Reverse polarity protection	Available
Ambient temperature (operational)	-25 °C...+40 °C
Storage temperature	-40 °C...+60 °C
Humidity	40°C / 93% rel. humidity, no condensation
Approvals	CSA; GOSTME25; MARITREG; CE
Insulation coordination (EN 50 178)	
Standards	EN 50178
Rated voltage	250 V
Impulse withstand voltage	4 kV
Clearance and creepage distances for control/load side	> 3 mm
Overvoltage category	III
Pollution severity	2
Protective separation acc. to VDE 0106 part 101	No
Dimensions	
Clamping range (nominal / min. / max.)	mm ² 2.5 / 0.5 / 4
Length x width x height	mm 70 / 25 / 63.5
Screw connection	
Note	

Ordering data

Input	24 V UC 2CO	115 V UC 2CO	230 V UC 2CO
Rated control voltage	24 V UC ±10 %	115 V UC +5 % / -15 %	230 V UC +5 % / -15 %
Rated current AC	28 mA	5 mA	4.3 mA
Rated current DC	18 mA	5 mA	4.3 mA
Power rating	0.6 W / 0.9 VA	0.5W / 0.6VA	1 W / 1 VA
AC Response/dropout Volt			
DC Response/dropout Volt	21.5V	98 V	195 V
AC pickup/dropout current	-/2.5mA	-/1.5mA	-/2 mA
DC pickup/dropout current	-/4.5mA	1mA	-/1.2mA

Ordering data	24 V UC 2CO	115 V UC 2CO	230 V UC 2CO
Type	RS 32 24VUC LD LP 2U	RS 32 115VUC LD LP 2U	RS 32 230VUC LD LP 2U
Order No.	9406221001	9406621001	9406721001
Type			
Order No.			

Ordering data	24 V UC 2CO	115 V UC 2CO	230 V UC 2CO

Note	24 V UC 2CO	115 V UC 2CO	230 V UC 2CO

RS SERIES - RS 32 - Relay modules

**2 CO contacts
multiple voltage input**



B

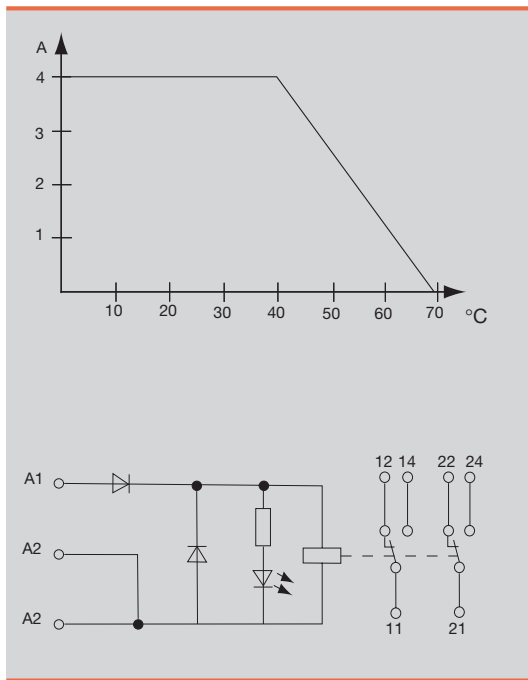

Output	
Switching voltage AC, max. / Continuous current	250 V / 4 A
min. switching capacity	10 V / 10 mA
Sparkover time / Drop-out time	13 ms / 10 ms
Contact material	AgNi 90/10
Mechanical service life	30*10 ⁶ switching cycles
Max. switching frequency at rated load	0.1 Hz
Rated data	
Status indicator / Free-wheel diode	red LED / No
Reverse polarity protection	Available
Ambient temperature (operational)	-25 °C...+40 °C
Storage temperature	-40 °C...+60 °C
Humidity	40°C / 93% rel. humidity, no condensation
Approvals	GOSTME25; CE
Insulation coordination (EN 50 178)	
Standards	EN 50178
Rated voltage	250 V
Impulse withstand voltage	4 kV
Clearance and creepage distances for control/load side	> 3 mm
Overtoltage category	III
Pollution severity	2
Protective separation acc. to VDE 0106 part 101	No
Dimensions	
Clamping range (nominal / min. / max.)	mm ² 2.5 / 0.5 / 4
Length x width x height	mm 70 / 25 / 63.5
Screw connection	
Note	

Ordering data

Input	24-48 V UC 2CO	115-230 V UC 2CO
Rated control voltage	24 V UC ±10 %, 48 V UC ±10 %	115 V UC +5 % / -15 %, 230 V UC +5 % / -15 %
Rated current AC	28 mA / 22 mA	5.6 mA / 5.3 mA
Rated current DC	18 mA / 20 mA	5.4 mA / 5 mA
Power rating	0.6 W / 0.9 VA	1W / 1VA
AC Response/dropout Volt		
DC Response/dropout Volt	21.5 V / 43 V	98 V / 195 V
AC pickup/dropout current	3 mA / 4.5 mA	1.5 mA / 2 mA
DC pickup/dropout current	5 mA / 2 mA	1 mA / 1.2 mA

Ordering data			
Screw connection	Type	RS 32 24-48VUC LD LP 2U	RS 32 115-230VUC LD 2U
	Order No.	1122661001	1122761001
	Type		
	Order No.		

Ordering data			
Note			



RS-SERIES – Relay modules

4-/8-/16-way, ea. with 1 COC

- Red LEDs, other colours on request
- Mounting feet can also be mounted turned through an angle of 180°

RSM 4 R / RSM 4 RS

4 relay modules soldered or plug-in

RSM 8 R / RSM 8 RS

8 relay modules soldered or plug-in

RSM 16 R / RSM 16 RS

16 relay modules soldered or plug-in

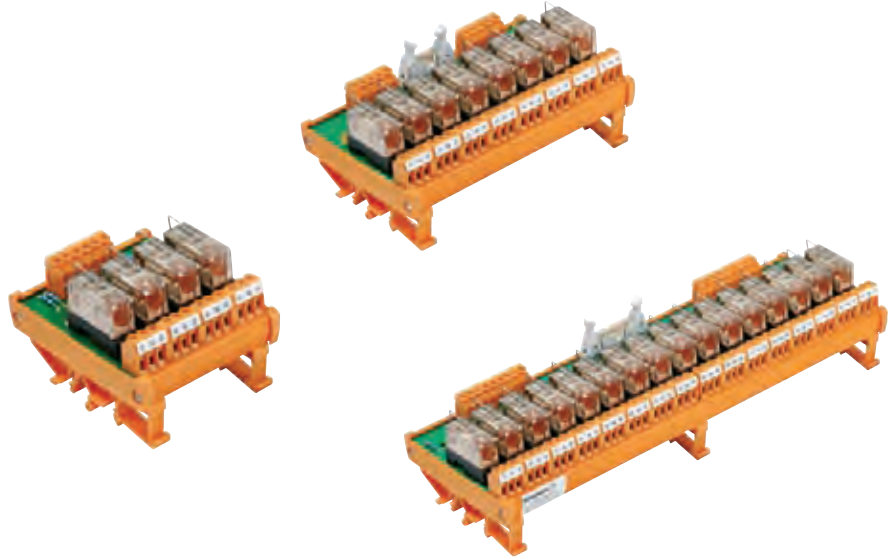

Technical data

Rated data	
Input voltage	
Nominal consumption DC	soldered relay module plug-in relay module
Nominal consumption AC	soldered relay module plug-in relay module
Pick-up current DC	soldered relay module plug-in relay module
Pick-up current AC	soldered relay module plug-in relay module

Drop-out current of relay module (at 20 °C)	
Output voltage max.	
Continuous current	

Derating curve
 a = fitted on mounting rail in horizontal row without spacing
 b = fitted on mounting rail in horizontal row with 20 mm spacing



24 V DC	24 V AC/DC	115 V AC/DC	230 V AC
0.45 W	–	–	–
0.75 W	0.45 W	–	–
–	–	–	–
–	0.7 VA	0.6 VA	1.2 VA
12 mA	–	–	–
23 mA	12 mA	5 mA	–
–	–	–	–
–	16.5 mA	6 mA	4 mA
2 mA	–	–	1 mA
250 V	250 V	250 V	250 V
6 A	6 A	6 A	3 A

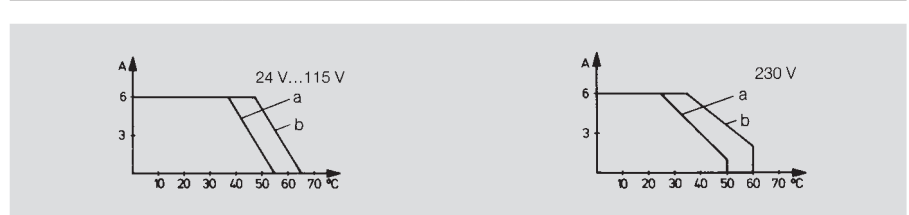

Typical making times	Pick-up delay (AC / DC) Drop-out delay (AC / DC)	≤ 8 ms ≤ 7 ms	≤ 10 ms / 10 ms ≤ 15 ms / 20 ms	≤ 8 ms / 10 ms ≤ 5 ms / 8 ms	≤ 10 ms ≤ 10 ms
Duration of bounce		≤ 3 ms			
Making current		8 A			
Making power under ohmic load		2000 VA			
Min. switching power / switching current		250 mW/10 mA			
Contact material		AgNi 90/10, AgNiO,15, gold-flashed			
Service life	mechanical 24 V DC, 1A, ohmic load 230 V AC, 3A, ohmic load	> 30 x 106 switching cycles > 5 x 105 switching cycles > 7 x 105 switching cycles			
Storage temperature		–40 °C...+60 °C			
Ambient temperature		–25 °C...+50 °C			
Humidity		40 °C/93 rel. humidity, no condensation			
Insulation coordination to EN 50178					
Surge category		III			
Pollution severity		2			
Dimensions					
Conductor cross-section (screw connection)		0.5...2.5 mm²			

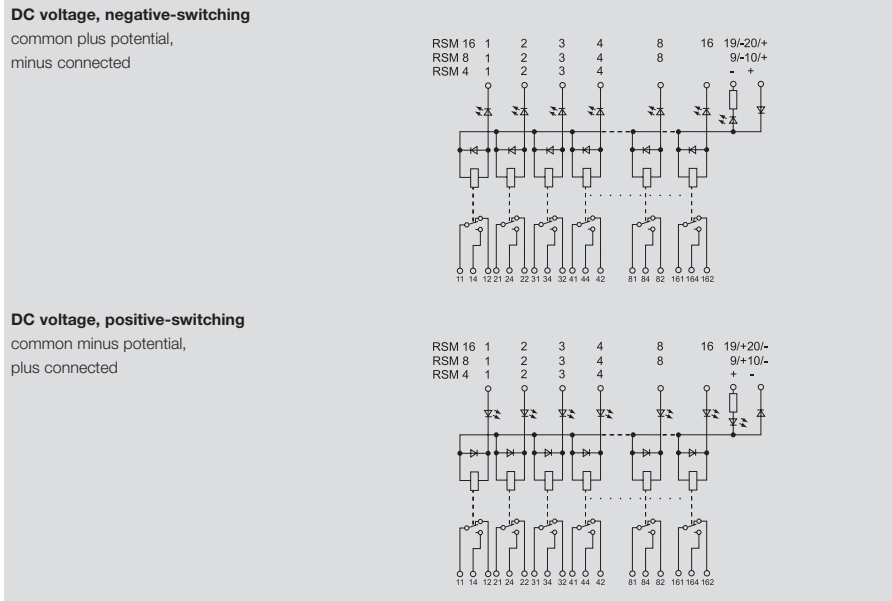
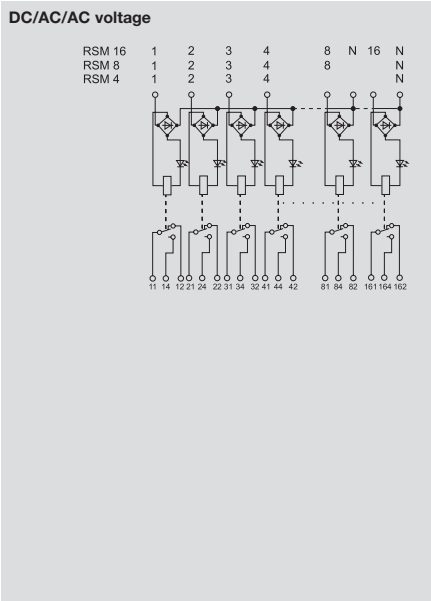

Ordering data

Connection system

Input **Screw connection**

- Plug-in relay module
Screw connection and multiple plug to IEC 603-1/DIN 41651
- Relay module soldered
Multiple plug to IEC 603-1/DIN 41651

Output **Screw connection**

		4 relay modules	8 relay modules	16 relay modules
Input voltage		RSM 4 R/RS	RSM 8 R/RS	RSM 16 R/RS
		(B = 75 mm)	(B = 145 mm)	(B = 285 mm)
24 V DC, switching plus	Relay module pluggable	1113361001	1113561001	1113761001
	Relay module soldered	1112361001	1107761001	1107861001
24 V DC, switching minus	Relay module pluggable	1113461001	1113661001	1113861001
24 V AC/DC	Relay module pluggable	1173461001	1173561001	1173661001
115 V AC/DC	Relay module pluggable	1114561001	1114661001	1114761001
230 V AC	Relay module pluggable	1114861001	1114961001	1115061001

Spare relay modules (pluggable)

For RSM ... R/RS, 24 V
For RSM ... R/RS, 48 V
For RSM ... R/RS, 115 V and 230 V

Input voltage	Contact material	Remarks	Order No.
24 V DC	AgNi 90/10	RT 314024 with clip	8630780000
	AgNi 90/10	RT 314024 without clip	4058480000
48 V DC	AgNi 90/10	RT 314048 without clip	4058740000
115 V DC	AgNi 90/10	RT 314110 with clip	8630770000
	AgNi 90/10	RT 314110 without clip	4058500000

Note: can also be ordered with clamp for conversion to new RSM relay module.

RSO-SERIES - Opto modules

RSO 30

- Pluggable connections
- DC output up to 3 A @ 5...60 V DC
- AC output up to 3 A @ 24...240 V AC
- 11 mm width

RSO 30-DV/SC



RSO 30-DV/SA

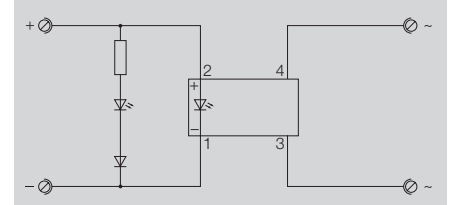
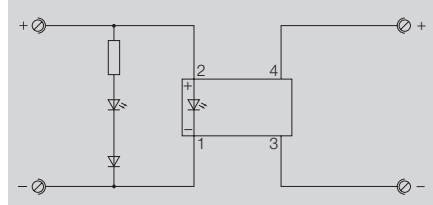
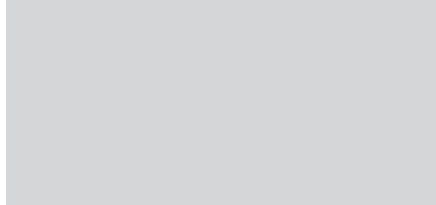

Technical data

Control side	
Rated control voltage	5...24 V DC ±20 %
Power rating	No
Rated auxiliary voltage	Green LED
Status indicator	
Load side	
Rated switching voltage	2...60 V DC
Rated switching current	3 A
Voltage drop at max. load	
Switch-on delay / Switch-off delay	0.1 ms / 0.75 ms
Short-circuit-proof / Protective circuit	No /
General data	
Ambient temperature (operational)	-25 °C...+40 °C
Storage temperature	-40 °C...+85 °C
Humidity	40°C / 93% rel. humidity, no condensation
Approvals	CE
Insulation coordination (EN 50 178)	
Standards	EN 50178
Rated voltage	300 V
Rated impulse withstand voltage	4 kV
Clearance and creepage distances for control/load side	≥ 8 mm
Overvoltage category	III
Pollution severity	2

Rated control voltage	5...24 V DC ±20 %
Power rating	No
Rated auxiliary voltage	Green LED
Status indicator	
Rated switching voltage	2...60 V DC
Rated switching current	3 A
Voltage drop at max. load	
Switch-on delay / Switch-off delay	0.1 ms / 0.75 ms
Short-circuit-proof / Protective circuit	No /
Ambient temperature (operational)	-25 °C...+40 °C
Storage temperature	-40 °C...+85 °C
Humidity	40°C / 93% rel. humidity, no condensation
Approvals	CE
Standards	EN 50178
Rated voltage	300 V
Rated impulse withstand voltage	4 kV
Clearance and creepage distances for control/load side	≥ 8 mm
Overvoltage category	III
Pollution severity	2

Rated control voltage	5...24 V DC ±20 %
Power rating	No
Rated auxiliary voltage	Green LED
Status indicator	
Rated switching voltage	24...250 V AC
Rated switching current	3 A
Voltage drop at max. load	1.6 V
Switch-on delay / Switch-off delay	No-voltage switch /
Short-circuit-proof / Protective circuit	No /
Ambient temperature (operational)	-25 °C...+40 °C
Storage temperature	-40 °C...+85 °C
Humidity	40°C / 93% rel. humidity, no condensation
Approvals	CE
Standards	EN 50178
Rated voltage	300 V
Rated impulse withstand voltage	4 kV
Clearance and creepage distances for control/load side	≥ 8 mm
Overvoltage category	III
Pollution severity	2

Dimensions	
Clamping range (nominal / min. / max.)	mm ² 2.5 / 0.5 / 2.5
Length x width x height	mm 80 / 11 / 50
Note	

Clamping range (nominal / min. / max.)	mm ² 2.5 / 0.5 / 2.5
Length x width x height	mm 80 / 11 / 50
Note	

Clamping range (nominal / min. / max.)	mm ² 2.5 / 0.5 / 2.5
Length x width x height	mm 80 / 11 / 50
Note	

Ordering data

Connection system

Type	Qty.	Order No.
RSO 30/DV 5-24V CC/SC	20	944310000

Type	Qty.	Order No.
RSO 30/DV 5-24V CC/SA	20	9443110000

Note

Note

Note

Accessories

Accessories

Accessories

Accessories



RSO 31

- Pluggable connections
- DC output up to 3 A @ 5...60 V DC
- AC output up to 3 A @ 24...240 V AC
- 12.5 mm width
- Pluggable fuse in output circuit

RSO 31 -ODC/F



RSO 31 -OAC/F

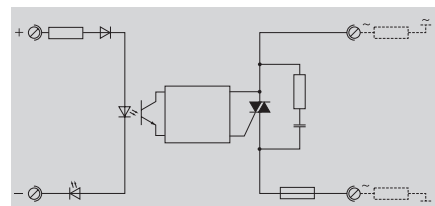
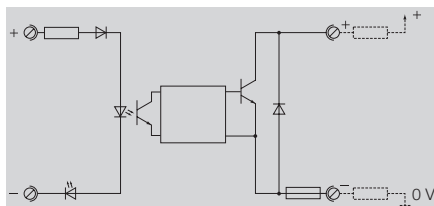

Technical data

Control side	
Rated control voltage	24 V DC ±10 %
Power rating	0.29 W
Rated auxiliary voltage	No
Status indicator	red LED
Load side	
Rated switching voltage	5...50 V DC
Rated switching current	3 A
Voltage drop at max. load	1.6 V
Switch-on delay / Switch-off delay	0.1 ms / 0.75 ms
Short-circuit-proof / Protective circuit	No /
General data	
Ambient temperature (operational)	-25 °C...+40 °C
Storage temperature	-40 °C...+85 °C
Humidity	40°C / 93% rel. humidity, no condensation
Approvals	CE
Insulation coordination (EN 50 178)	
Standards	EN 50178
Rated voltage	300 V
Rated impulse withstand voltage	4 kV
Clearance and creepage distances for control/load side	≥ 8 mm
Overvoltage category	III
Pollution severity	2

Control side	
Rated control voltage	24 V DC ±10 %
Power rating	0.29 W
Rated auxiliary voltage	No
Status indicator	red LED
Load side	
Rated switching voltage	24...250 V AC
Rated switching current	3 A
Voltage drop at max. load	1.6 V
Switch-on delay / Switch-off delay	No-voltage switch /
Short-circuit-proof / Protective circuit	No /
General data	
Ambient temperature (operational)	-25 °C...+40 °C
Storage temperature	-40 °C...+85 °C
Humidity	40°C / 93% rel. humidity, no condensation
Approvals	CE
Insulation coordination (EN 50 178)	
Standards	EN 50178
Rated voltage	300 V
Rated impulse withstand voltage	4 kV
Clearance and creepage distances for control/load side	≥ 8 mm
Overvoltage category	III
Pollution severity	2

Control side	
Rated control voltage	24 V DC ±10 %
Power rating	0.29 W
Rated auxiliary voltage	No
Status indicator	red LED
Load side	
Rated switching voltage	24...250 V AC
Rated switching current	3 A
Voltage drop at max. load	1.6 V
Switch-on delay / Switch-off delay	No-voltage switch /
Short-circuit-proof / Protective circuit	No /
General data	
Ambient temperature (operational)	-25 °C...+40 °C
Storage temperature	-40 °C...+85 °C
Humidity	40°C / 93% rel. humidity, no condensation
Approvals	CE
Insulation coordination (EN 50 178)	
Standards	EN 50178
Rated voltage	300 V
Rated impulse withstand voltage	4 kV
Clearance and creepage distances for control/load side	≥ 8 mm
Overvoltage category	III
Pollution severity	2

Dimensions	
Clamping range (nominal / min. / max.)	mm ² 2.5 / 0.5 / 2.5
Length x width x height	mm 80 / 12.5 / 65.5
Note	

Dimensions	
Clamping range (nominal / min. / max.)	mm ² 2.5 / 0.5 / 2.5
Length x width x height	mm 80 / 12.5 / 65.5
Note	

Dimensions	
Clamping range (nominal / min. / max.)	mm ² 2.5 / 0.5 / 2.5
Length x width x height	mm 80 / 12.5 / 65.5
Note	

Ordering data

Connection system

Type	Qty.	Order No.
RSO31-ODC24/F	20	9430820000

Type	Qty.	Order No.
RSO31-OAC24/F	20	9430320000

Note

Note

Note

Accessories

Accessories

Accessories

Accessories

