

# Signal monitoring in safety-critical circuits

## Coupling relays with positively driven contacts

Weidmüller has expanded the RIDERSERIES to include a relay variant with force-guided contacts. Relays with force-guided contacts have a 99 % diagnostics coverage and an excellent reputation for use in safety systems. The contacts interlock mechanically with each other in order to ensure a synchronous switching status of both contacts. This guarantees that the alert contact will maintain the same switching status in the event of an error (for example, if the working contact melts from an overload). The controller (or safety controller) detects the alert contact and then compares the set point and actual values. If a difference occurs, measures can then be taken to protect equipment and human life.

### Resistant to vibration

A metal clip ensures that the relay module remains secure even under vibration / mechanical shock conditions.

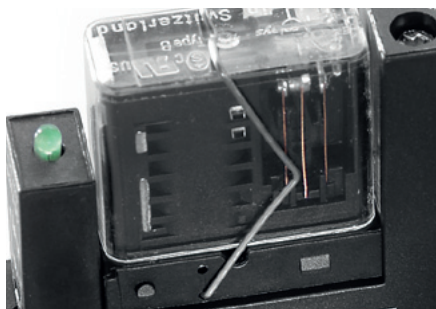
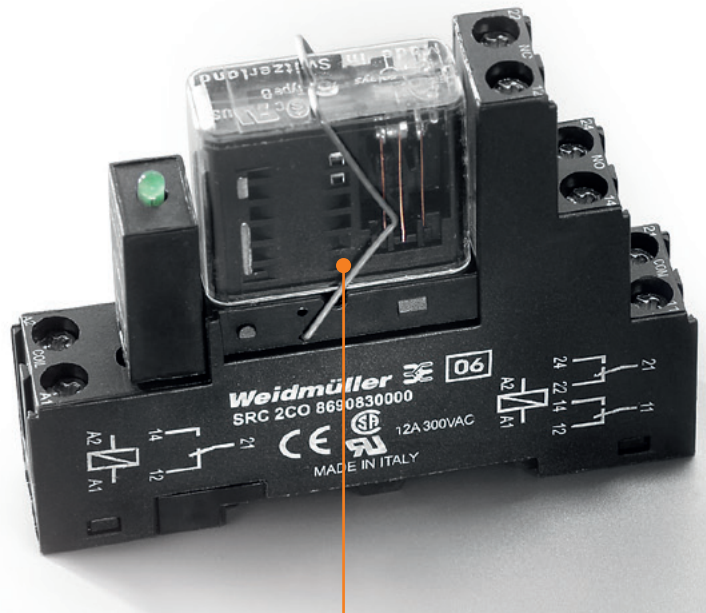

### A variety of connection options

The base is available either with the proven screw clamp connection or the time saving tension clamp connection.

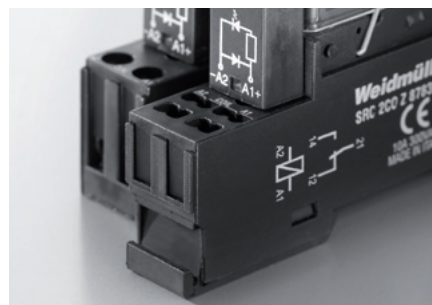

**Convenient**

Relay modules can be replaced quickly in the event of a fault without removing the connecting cable.

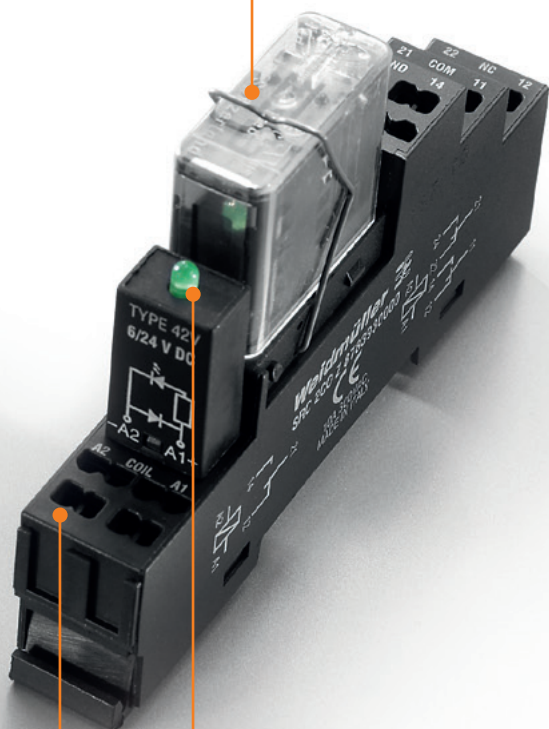
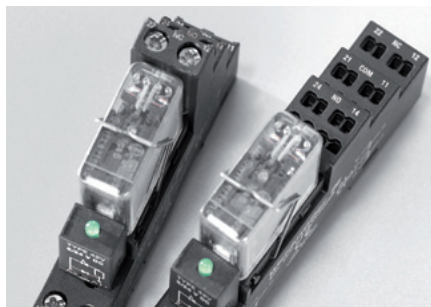

**On site diagnostics**

An easy to view LED display module with an integrated free wheeling diode is used to protect the series connected electronics.

**Safety-based output relay controls**

By connecting two coupling relays together with a safety based controller or safety switching devices, it is possible to set up a safe and efficient control mechanism that complies with the structure specified in EN ISO 13849-1 (Category 3 and 4).

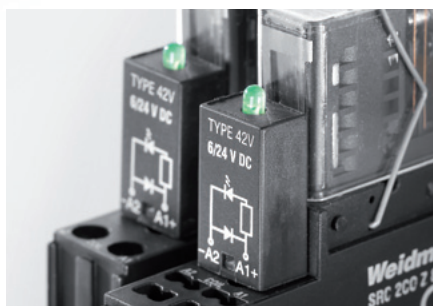
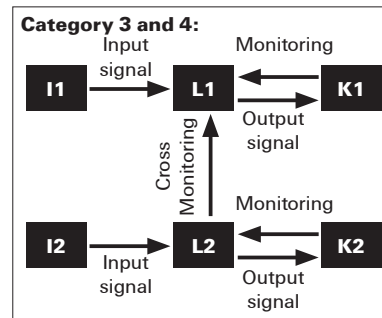

**RIDERSERIES FG – relay modules**

**RCI KIT with forcibly guided contacts**

**2 CO DC coil**

Modular system comprising of:

- Relay socket for rail mounting
- LED indicator unit
- Retaining clip
- Pluggable relay modules
- Markers



**B**

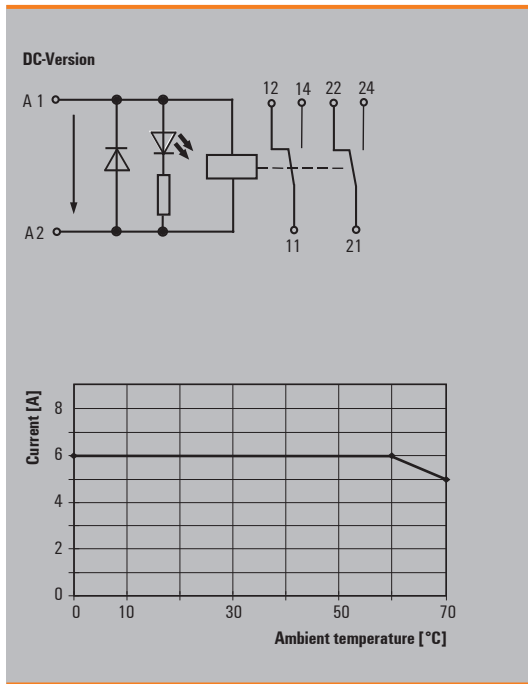

**Technical data**

<b>Output</b>		
Rated switching voltage / Continuous current	250 V AC / 6 A	
Max. switching voltage, AC	250 V	
Making current	15 A / 20 ms	
Min. switching power	100 mA / 5 V, 10 V / 10 mA, 24 V / 1 mA	
Max. switching power	1500 VA	
Contact material	AgCuNi	
Mechanical service life	> 50 x 10 <sup>6</sup> switching cycles	
Max. switching frequency at rated load	20 Hz	
<b>Rated data</b>		
Ambient temperature (operational)	-40 °C...+70 °C	
Storage temperature	-40 °C...+85 °C	
Humidity	40 °C / 95 % rel. humidity, no condensation	
Approvals	CE	
<b>Insulation coordination (EN 50178)</b>		
Rated voltage	250 V	
Impulse withstand voltage		
Dielectric strength input - output	5 kV <sub>eff</sub> / 1 min	
Dielectric strength, contact / contact	4 kV <sub>eff</sub> / 1 min	
Dielectric strength to mounting rail		
Creepage and clearance distance input - output	≥ 10 mm	
Surge voltage category	III	
Pollution severity	3	
<b>Dimensions</b>		
	<b>Screw connection</b>	<b>Tension clamp connection</b>
Clamping range (nominal / min. / max.)	mm <sup>2</sup> 2.5 / 0.5 / 2.5	1.5 / 0.5 / 1.5
Depth x width x height	mm 62 / 15.5 / 77	63.2 / 16 / 97
<b>Note</b>		

**Ordering data**

<b>Input</b>		<b>24 V DC 2CO LED</b>
Rated control voltage		24 V DC
Rated current AC / DC		/ 35.8 mA
Power rating		0.82 W
AC response/dropout Volt		
DC response/dropout Volt		18 V / 2.4 V
Status indicator		Green LED
Protective circuit		Integrated free-wheel diode
<b>Output</b>		
Switch-on delay		≤ 12 ms
Switch-off delay		≤ 6 ms

<b>Ordering data</b>		
Screw connection	Type	RCIKIT 24VDC 2CO LD/FG
	Order No.	<b>1218410000</b>
Tension clamp connection	Type	RCIKITZ 24VDC 2CO LD/FG
	Order No.	<b>1218390000</b>

<b>Ordering data</b>		
<b>Spare relay</b>		
	Type	RCI42424FG
	Order No.	<b>1218380000</b>

<b>Note</b>		
-------------	--	--