

DELCON Series Relays

The optimal interface relay for demanding industrial applications

NEW

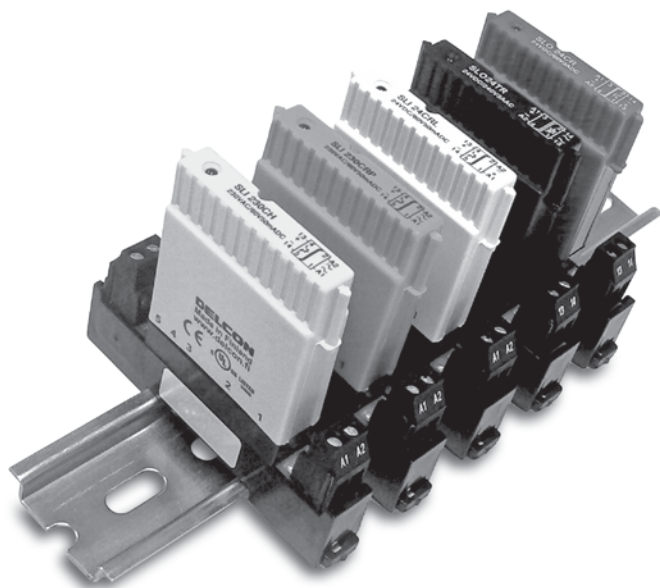

Pulse transformer technology for isolating I/O signals offers significant advantages over optical isolation and electromechanical relays. Most notably, pulse transformer I/O modules provide higher transient immunity and high input-to-output isolation.

The high transient immunity means the Weidmüller - Delcon I/O modules are ideal for I/O applications where electrical noise is a problem. No additional suppression components are needed even when used with long unshielded signal cables, inductive loads or 'noisy' power lines.

The limitations of optocoupler based solid-state relays disappear when pulse transformer I/O modules are used. For instance, the standard AC output module SLO 24TR has near zero leakage current; requires no minimum load; can be used with any power factor 0 to 1; is rated for both general use and inductive loads at 3A; and is immune to both load line and signal line spikes.

Features:

- virtually no off-state leakage currents
- high current and high voltage DC output versions
- Wide operating temperature range from -25°C to +70°C
- compact packaging
- optional rail mounting base
- high surge current rating
- fast switching
- large selection of input and output types
- industry standard pin connection
- cULus listed

DELCON Series Relays

Innovative – Finnish – Delcon

Delcon has manufactured pulse transformer technology based solid-state relays for demanding industrial applications since the end of the 70's. Delcon has its product development and assembly near Helsinki, Finland. The extremely high quality of the products is guaranteed by the design, the choice of the right components, good workmanship and 100 % testing.

Avoid production downtime

Customers choose Delcon because of reliability, safe operation and costs savings in maintenance due to fewer unexpected production stoppages.

Add reliability to a control system

Delcon Series relays improve the reliability of the whole control system. The exceptionally clear function and condition indication of Delcon Series relays is based on a unique current-voltage-hysteresis that guarantees 100 % switching and signalling even under the worst conditions.

Voltage/current - signal diagram

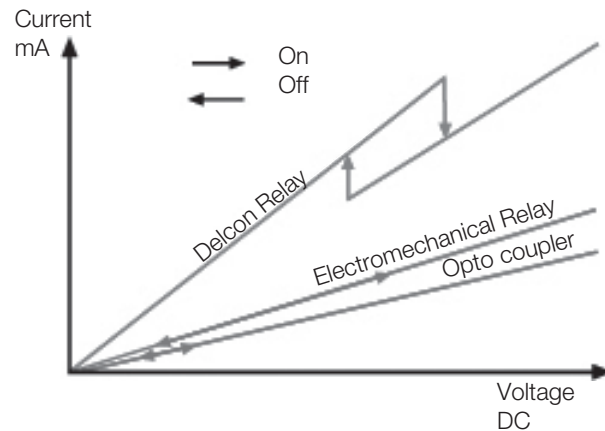

AC relays are immune from interference and guarantee safe switching and reliable signal indication with

- Long and/or parallel signal and load cables
- Unshielded cables
- 2-wire sensors
- Fast operations, off-delay 0.5 ms
- High switching frequencies up to 1000 Hz
- High momentary currents of up to 30 x I_n

Highly reliable DC relays also for extremely difficult loads

- Switch 4 amp DC-loads with voltages of up to 250 V without problems and without derating
- Switch difficult and highly inductive loads such as solenoid valves having time factors as high as 100 ms
- Have a long lifetime with high currents (up to 10 A / 24 VDC)

Loading capacity, AC Relays

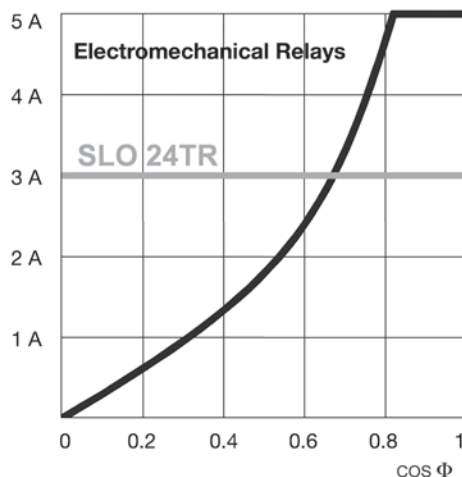

Loading capacity, DC Relays

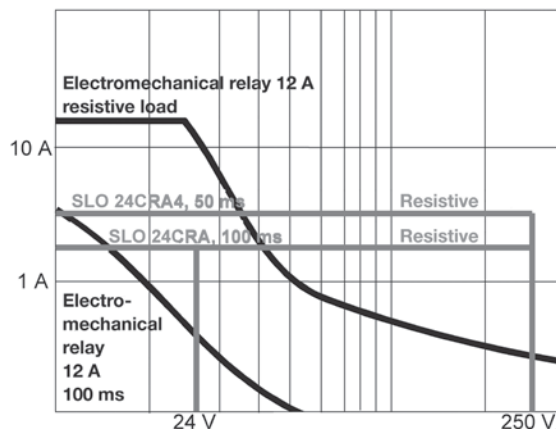

AC apps. / input relays - DC low current output

Color	Plug-in relay	Description	Control voltage	Input impedance	Max. load current	Load voltage	Power factor range
Yellow	SLI 25CR	regular operation	24 VAC	2.0 kΩ	0 - 50 mA	0 - 60 VDC	Resistive load
Yellow	SLI 49CR	regular operation	48 VAC	4.0 kΩ	0 - 50 mA	0 - 60 VDC	Resistive load
Yellow	SLI 120CRI	normally closed	120 VAC	20.0 kΩ	0 - 100 mA	0 - 60 VDC	Resistive load
Yellow	SLI 120CH	transient protection added on output	120 VAC	20.0 kΩ	0 - 50 mA	0 - 60 VDC	Resistive load
Yellow	SLI 120CR	regular operation	120 VAC	20.0 kΩ	0 - 50 mA	0 - 60 VDC	Resistive load
Orange	SLI 120CRP	3.5mA leakage immunity on input	120 VAC	20.0 kΩ	0 - 50 mA	0 - 60 VDC	Resistive load
Yellow	SLI 230CH	transient protection added on input	230 VAC	45.0 kΩ	0 - 50 mA	0 - 60 VDC	Resistive load
Yellow	SLI 230CR	regular operation	230 VAC	45.0 kΩ	0 - 50 mA	0 - 60 VDC	Resistive load
Yellow	SLI 230CRI	normally closed	230 VAC	45.0 kΩ	0 - 100 mA	0 - 60 VDC	Resistive load
Orange	SLI 230CRP	3.5mA leakage immunity on input	230 VAC	45.0 kΩ	0 - 50 mA	0 - 60 VDC	Resistive load

DC apps / input relays - DC low current output

Color	Plug-in relay	Description	Control voltage	Input impedance	Max. load current	Load voltage	Power factor range
White	SLI 12CR	regular operation	12 VDC	1.8 kΩ	0 - 50 mA	0 - 60 VDC	Resistive load
White	SLI 24CR	regular operation	24 VDC	4.0 kΩ	0 - 50 mA	0 - 60 VDC	Resistive load
White	SLI 24CRF	fast switching, 10,000 Hz	24 VDC	4.0 kΩ	0 - 50 mA	0 - 60 VDC	Resistive load
White	SLI 24CRL	to maintain min. input load 15 mA	24 VDC	1.3 kΩ	0 - 50 mA	0 - 60 VDC	Resistive load
White	SLI 48CR	regular operation	48 VDC	8.0 kΩ	0 - 50 mA	0 - 60 VDC	Resistive load
White	SLI 125CH	transient protection added on input	125 VDC	32.0 kΩ	0 - 50 mA	0 - 60 VDC	Resistive load
White	SLI 125CR	regular operation	125 VDC	32.0 kΩ	0 - 50 mA	0 - 60 VDC	Resistive load
White	SLI 250CH	transient protection added on input	250 VDC	68.0 kΩ	0 - 50 mA	0 - 60 VDC	Resistive load
White	SLI 250CR	regular operation	250 VDC	68.0 kΩ	0 - 50 mA	0 - 60 VDC	Resistive load

Plug-in bases Description

9908910000	TS32/TS35 DIN Rail Mounting base— Screw Clamp (19.6mm wide)
MIS1CCN	TS35 DIN Rail Mounting base— Tension Clamp (12.8mm wide)
MIS1N	TS35 DIN Rail Mounting base— Screw Clamp (12.8mm wide)

1 Channel - Input rail mountable base

Part No. 9908910000

Input modules

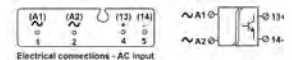
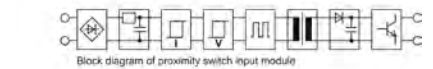
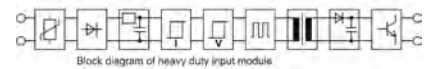
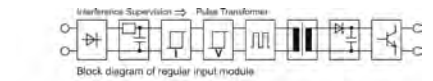
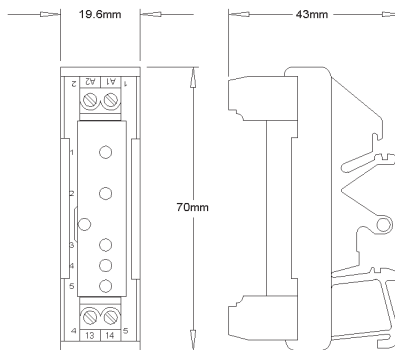
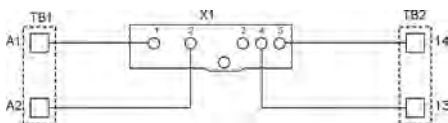

1 Channel - Input rail mountable base

Part No. MIS1N

Connections for MIS1N

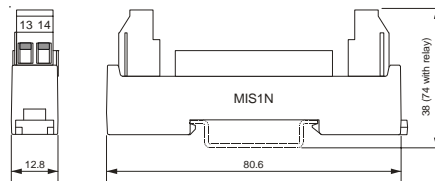
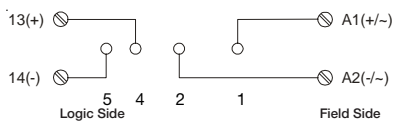

1 Channel - Input rail mountable base

Part No. MIS1CCN

Connections for MIS1CCN

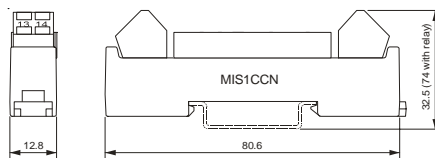
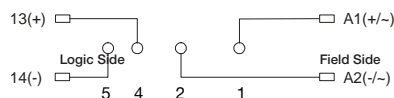

AC apps. / output relays - AC/DC input voltage

Color	Plug-in relay	Description	Control voltage	Input impedance	Max. load current	Load voltage	Power factor range
Black	SLO 5IRA	fast AC switching, off-delay 0.5 ms	5 VDC	0.42 kΩ	0 - 1.2 A	0 - 240 VAC/DC	0.3 - 1 @ 1.2 A AC
Black	SLO 5TR	regular operation	5 VDC	3.0 kΩ	0 - 3 A	0 - 240 VAC	0 - 1
Black	SLO 12TR	regular operation	12 VDC	1.0 kΩ	0 - 3 A	0 - 240 VAC	0 - 1
Black	SLO 24IRA	fast AC switching, off-delay 0.5 ms	24 VDC	2.0 kΩ	0 - 1.2 A	0 - 240 VAC/DC	0.3 - 1 @ 1.2 A AC
Black	SLO 24TH	transient protection added	24 VDC	1.4 kΩ	0 - 3 A	0 - 240 VAC	0 - 1
Black	SLO 24TR	regular operation	24 VDC	1.6 kΩ	0 - 3 A	0 - 240 VAC	0 - 1
Black	SLO A120TR	regular operation	120 VAC	24.0 kΩ	0 - 1 A	0 - 240 VAC	0 - 1
Black	SLO P120TR	2mA leakage immunity on input	120 VAC	24.0 kΩ	0 - 3 A	0 - 240 VAC	0 - 1
Black	SLO A230TR	regular operation	230 VAC	46.0 kΩ	0 - 1 A	0 - 240 VAC	0 - 1
Black	SLO P230TR	2mA leakage immunity on input	230 VAC	46.0 kΩ	0 - 1.5 A	0 - 240 VAC	0 - 1
Black	SRO 24M	electromechanical relay, make (NO)	24 VDC	2.7 kΩ	0 - 6 A	240 VAC	Resistive load @ 3 A
Black	SRO 24B	electromechanical relay, break (NC)	24 VDC	2.7 kΩ	0 - 3 A	240 VAC	Resistive load @ 3 A

DC apps / output relays - DC input voltage

Color	Plug-in relay	Description	Control voltage	Input impedance	Max. load current	Load voltage	Power factor range
Red	SLO 5CRA	100 ms time constant*	5 VDC	0.42 kΩ	0 - 1.8 A	0 - 250 VDC	L/R = 100 ms @ 24V 1.8 A **
Red	SLO 5CR	normal use	5 VDC	0.42 kΩ	0 - 3 A	0 - 60 VDC	L/R = 5 ms @ 24 V 2 A **
Red	SLO 5CRX	high current, resistive load	5 VDC	0.42 kΩ	0 - 10 A	0 - 24 VDC	L/R = 2 ms @ 24 V 5 A **
Red	SLO 12CR	normal use	12 VDC	1.3 kΩ	0 - 3 A	0 - 60 VDC	L/R = 5 ms @ 24 V 2 A **
Red	SLO 12CRA	100 ms time constant*	12 VDC	1.3 kΩ	0 - 1.8 A	0 - 250 VDC	L/R = 100 ms @ 24 V 1.8 A **
Red	SLO 12CRX	high current, resistive load	12 VDC	1.3 kΩ	0 - 10 A	0 - 24 VDC	L/R = 2 ms @ 24 V 5 A **
Red	SLO 24CRA	100 ms time constant*	24 VDC	2.0 kΩ	0 - 1.8 A	0 - 250 VDC	L/R = 100 ms @ 24 V 1.8 A **
Red	SLO 24CR	normal use	24 VDC	2.0 kΩ	0 - 3 A	0 - 60 VDC	L/R = 5 ms @ 24 V 2 A **
Red	SLO 24CL	low input current	24 VDC	13.0 kΩ	0 - 3 A	0 - 60 VDC	L/R = 5 ms @ 24 V 2 A **
Red	SLO 24CRA4	50 ms time constant*	24 VDC	13.0 kΩ	0 - 4 A	0 - 250 VDC	L/R = 50 ms @ 24 V 4 A **
Red	SLO 24CRX	high current, resistive load	24 VDC	2.0 kΩ	0 - 10 A	0 - 24 VDC	L/R = 2 ms @ 24 V 5 A **

* L/R max. @ 24 V load voltage and max. current

** L/R depends on V and I

Plug-in bases	Description
9908920000	TS32/TS35 DIN Rail Mounting base— Screw Clamp (19.6mm wide)
MOS1CCN	TS35 DIN Rail Mounting base— Tension Clamp (12.8mm wide)
MOS1N	TS35 DIN Rail Mounting base— Screw Clamp (12.8mm wide)

1 Channel - Output rail mountable base

Part No. 9908920000

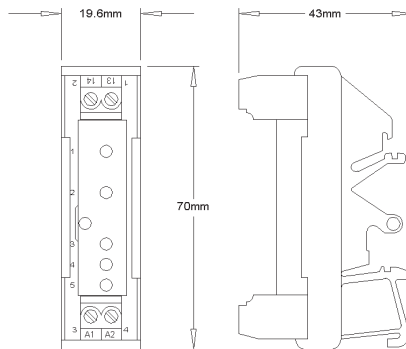
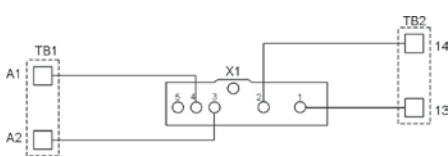

Output modules

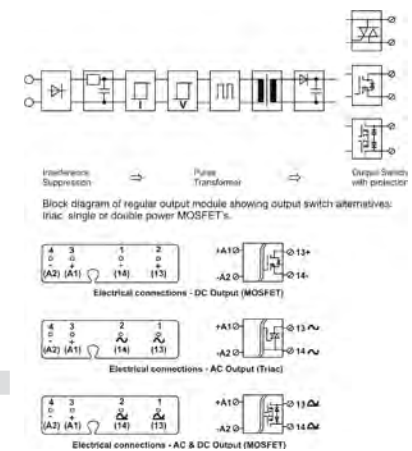

1 Channel - Output rail mountable base

Part No. MOS1N

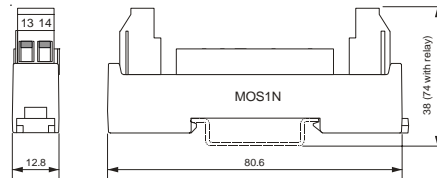
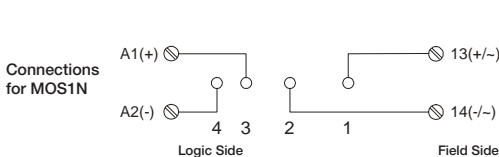

1 Channel - Output rail mountable base

Part No. MOS1CCN

