

# Switching Power Supplies: PS5R-V Series



## STANDARDS COMPLIANCE

Applicable Standards	Mark	File No. or Organization
UL508 UL1310*1 ANSI/ISA 12.12.01 CSA C22.2 No.107.1 CSA C22.2 No.213 CSA C22.2 No.223*1		UL/c-UL Listed File No. E467154, E177168
EN60950-1 EN50178 EN61204-3	 	TÜV SÜD EU Low Voltage Directive, EMC Directive
SEMI F47	—	EPRI

\*1: PS5R-VB/VC/VD only

## POWER SUPPLY PART NUMBERS

Output Capacity	Part Number	Input Voltage	Output Voltage	Output Current
10W	PS5R-VB05	100 to 240V AC (Voltage range: 85 to 264V AC / 100 to 370V DC)	5V	2.0A
15W	PS5R-VB12		12V	1.3A
	PS5R-VB24		24V	0.65A
30W	PS5R-VC12		12V	2.5A
	PS5R-VC24		24V	1.3A
60W	PS5R-VD24		24V	2.5A
120W	PS5R-VF24	24V	5.0A	

## Part Number Structure

PS5R - V □ □

Output Voltage  
05: 5V\*3  
12: 12V\*4  
24: 24V

Output Capacity  
B: 10W/15W  
C: 30W  
D: 60W  
F: 120W

\*3: PS5R-VB only

\*4: PS5R-VB/VC only

Note: Use only for interpreting part numbers.  
Do not use for developing part numbers.

## PRODUCT DESCRIPTION

Space saving DIN-rail mount switching power supplies with global approvals for both industrial and hazardous locations.

## KEY FEATURES

- Compact size preserves panel space
- Slim size (width):  
22.5mm (10W/15W/30W)  
36mm (60W)  
46mm (120W)
- Universal Voltage Input:  
85-264V AC/100-370V DC
- Wide operating temperature range
- Spring-up terminals accept ring & fork terminals
- Approved for use in Class I Division 2 hazardous locations
- Can be installed in 6 directions
- DIN-rail or panel mount
- Overcurrent protection with auto-reset
- Meets SEMI F47 Sag Immunity (208V AC input)
- RoHS compliant
- Five-year factory warranty



# SPECIFICATIONS

Model	5V DC output	PS5R-VB05	-	-	-		
	12V DC output	PS5R-VB12	PS5R-VC12	-	-		
	24V DC output	PS5R-VB24	PS5R-VC24	PS5R-VD24	PS5R-VF24		
<b>Output Capacity</b>		15W (5V Model is 10W)	30W	60W	120W		
<b>Input</b>	<b>Rated Input Voltage (Single-phase two-wire)*1</b>	100 to 240V AC (Voltage range: 85 to 264V AC/100 to 370V DC) (Load ≤ 80% at 100-105V DC)					
	<b>Frequency</b>	50/60 Hz					
	<b>Input Current (Typ.)</b>	<b>100V AC</b>	5V: 0.25A 12V, 24V: 0.35A	0.7A	1.3A	1.4A	
		<b>230V AC</b>	5V: 0.14A 12V, 24V: 0.19A	0.3A	0.8A	0.7A	
	<b>Inrush Current (Typ.)</b>	<b>100V AC</b>	18A (Ta = 25°C, cold start)				
		<b>230V AC</b>	45A (Ta = 25°C, cold start)				
	<b>Leakage Current</b>	<b>120V AC</b>	0.5mA max.				
		<b>230V AC</b>	1.0mA max.				
	<b>Efficiency (Typ.) (at rated output)*2</b>	<b>100V AC</b>	5V: 77%, 12V: 82%, 24V: 84%	12V: 83%, 24V: 85%	86%	88%	
		<b>230V AC</b>	5V: 73%, 12V: 80%, 24V: 81%	12V: 85%, 24V: 87%	86%	89%	
<b>Power Factor (Typ.)</b>	<b>100V AC</b>	—			0.99		
	<b>230V AC</b>	—			0.92		
<b>Output</b>	<b>Rated Voltage/Current</b>	5V/2.0A*3, 12V/1.3A, 24V/0.65A	12V/2.5A, 24V/1.3A	24V/2.5A	24V/5A		
	<b>Adjustable Voltage Range</b>	±10%					
	<b>Output Holding Time (Typ.) (at rated output)</b>	<b>100V AC</b>	5V: 53ms, 12V: 34ms, 24V: 36ms	12V: 13ms, 24V: 15ms	13ms	30ms	
		<b>230V AC</b>	5V: 330ms 12V: 215ms 24V: 230ms	12V: 110ms 24V: 110ms	105ms	33ms	
	<b>Start Time (at rated input and output)</b>	500ms max.		600 ms max.	800 ms max.	700 ms max.	
	<b>Rise Time (at rated input and output)</b>	5V, 12V: 200ms max. 24V: 250ms max.	200ms max.				
	<b>Regulation</b>	<b>Input Fluctuation</b>	0.4% max.				
		<b>Load Fluctuation</b>	5V: 2.5% max. 12V, 24V: 1.0% max.	1.0% max.			
		<b>Temperature Change</b>	0.05%/°C max. (-10 to +65°C)		12V: 0.05%/°C max. (-10 to +50°C) 24V: 0.05%/°C max. (-10 to +55°C)	0.05%/°C max. (-10 to +55°C)	0.05%/°C max. (-25 to +55°C)
		<b>Ripple (including noise)</b>	5V: 8% p-p max. (-25 to -10°C) 12V: 6% p-p max. (-25 to -10°C) 24V: 4% p-p max. (-25 to -10°C)	12V: 6% p-p max. (-25 to -10°C) 24V: 4% p-p max. (-25 to -10°C)	4% p-p max. (-25 to -10°C)		4% p-p max. (-25 to -10°C)
5V: 5% p-p max. (-10 to +0°C) 12V: 2.5% p-p max. (-10 to +0°C) 24V: 1.5% p-p max. (-10 to +0°C)			12V: 2.5% p-p max. (-10 to +0°C) 24V: 1.5% p-p max. (-10 to +0°C)	1.5% p-p max. (-10 to +0°C)		1.5% p-p max. (-10 to +0°C)	
	5V: 2.5% p-p max. (0 to +65°C) 12V: 1.5% p-p max. (0 to +65°C) 24V: 1% p-p max. (0 to +65°C)	12V: 1.5% p-p max. (0 to +50°C) 24V: 1% p-p max. (0 to +55°C)	1% p-p max. (0 to +55°C)		1% p-p max. (0 to +55°C)		
<b>Overcurrent Protection</b>	105% min. (auto reset)						
<b>Operation Indicator</b>	LED (green)						
<b>Dielectric Strength</b>	Between input and output terminals: 3,000V AC, 1 minute Between input and ground terminals: 2,000V AC, 1 minute Between output and ground terminals: 500V AC, 1 minute						
<b>Insulation Resistance</b>	Between input and output terminals: 100MΩ min. (500V DC megger) Between input and ground terminals: 100MΩ min. (500V DC megger)						
<b>Operating Temperature*4</b>	-25 to +75°C	-25 to +70°C		-25 to +65°C			
<b>Operating Humidity</b>	20 to 90% RH (no condensation)						
<b>Storage Temperature</b>	-25 to +75°C						
<b>Storage Humidity</b>	20 to 90% RH (no condensation)						
<b>Vibration Resistance</b>	10 to 55Hz, amplitude 0.375mm, 2 hours each in 3 axes (when used with BNL6 end clips)		10 to 55Hz, amplitude 0.33mm, 2 hours each in 3 axes (when used with BNL6 end clips) 10 to 55Hz, amplitude 0.375mm, 2 hours each in 3 axes (when used with BNL8 end clips)		10 to 55Hz, amplitude 0.21mm, 2 hours each in 3 axes (when used with BNL6 end clips) 10 to 55Hz, amplitude 0.375mm, 2 hours each in 3 axes (when used with BNL8 end clips)		
<b>Shock Resistance</b>	300 m/s <sup>2</sup> (30G), 3 times each in 6 directions						
<b>Expected Life*5</b>	8 years minimum (at the rated input, 50% load, operating temperature +40°C, standard mounting direction)						
<b>EMC</b>	<b>EMI</b>	EN61204-3 (Class B)					
	<b>EMS</b>	EN61204-3 (industrial)					
<b>Safety Standards</b>	UL508 (Listing), UL1310 Class 2 ANSI/ISA-12.12.01 CSA C22.2 No. 107.1, 213, 223 EN60950-1, EN50178			UL508 (Listing) ANSI/ISA-12.12.01 CSA C22.2 No. 107.1, 213 EN60950-1, EN50178			
<b>Other Standard</b>	SEMI F47 (at 208V AC input only)						
<b>Degree of Protection</b>	IP20 (EN60529)						
<b>Dimensions (mm)</b>	90H × 22.5W × 95D			95H × 36W × 108D	115H × 46W × 121D		
<b>Weight (approx.)</b>	140g	150g		260g	470g		
<b>Terminal Screw</b>	M3.5						

At normal temperature and humidity unless otherwise specified.

\*1: DC input voltage is not subject to safety standards. When using on DC input, connect a fuse to the input terminal for DC input protection.

\*2: Under stable state. \*3: PS5R-VB05 (5V DC/2.0A) is 10W (Up to 3.0A at Ta = 0 to 40°C. Not subject to safety standards above 2.0A.)

\*4: See the output derating curves on page 3.

\*5: Calculation of the expected life is based on the actual life of the aluminum electrolytic capacitor. The expected life depends on operating conditions.

# CHARACTERISTICS

## Operating Temperature vs. Output Current (Derating Curves)

Conditions: Natural air cooling (Operating temperature is the temperature around the switching power supply.)

**PS5R-VB05, -VB12, -VB24**

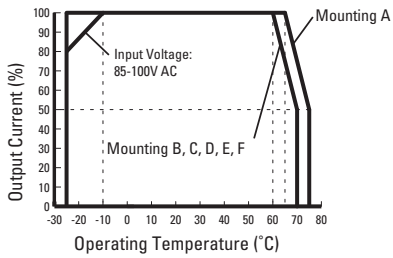

**PS5R-VC12**

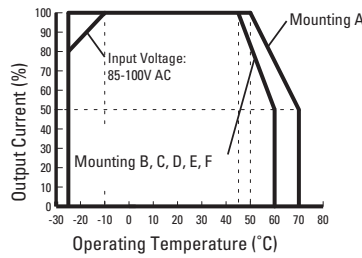

**PS5R-VC24**

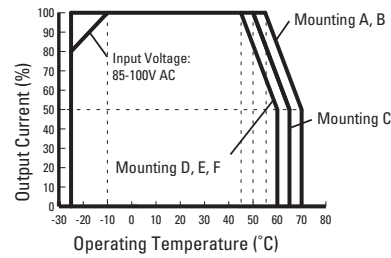

**PS5R-VD24**

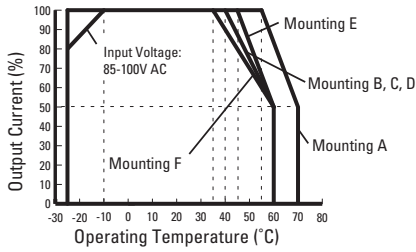

**PS5R-VF24**

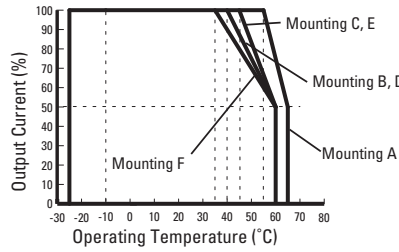

## Overcurrent Protection Characteristics

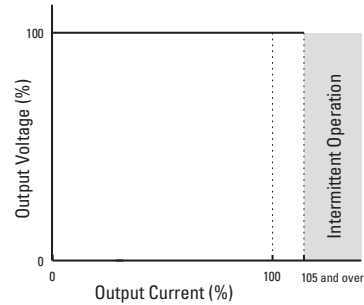

## Operating Temperature Approved by Safety Standards

Part Number	UL508, CSA C22.2 No.107.1, ANSI/ISA12.12.01, EN60950-1, EN50178					
	Mounting A	Mounting B	Mounting C	Mounting D	Mounting E	Mounting F
PS5R-VB05, -VB12, -VB24	65	60	60	60	60	60
PS5R-VC12	50	45	45	45	45	45
PS5R-VC24	55	55	50	45	45	45
PS5R-VD24	55	40	40	40	45	35
PS5R-VF24	55	40	45	40	45	35

## Mounting Style

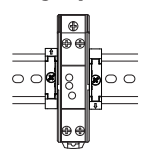

Mounting A  
(Vertical, standard)

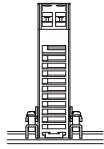

Mounting B  
(Upright)

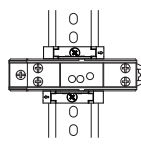

Mounting C  
(Left side up)

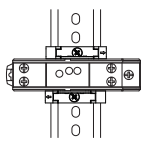

Mounting D  
(Right side up)

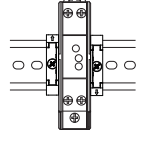

Mounting E  
(Upside down)

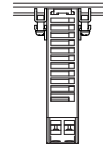

Mounting F  
(Downward)



**PS5R-VB/VC**

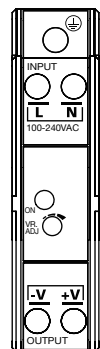

**PS5R-VD/VF**

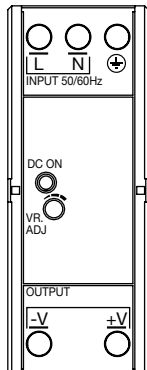

Marking	Name	Description
L, N	AC Input Terminal	Voltage range: 85 to 264V AC/100 to 370V DC
⊕	Ground Terminal	Be sure to connect this terminal to a proper ground.
+V, -V	DC Output Terminals	+V: Positive output terminal -V: Negative output terminal
VR.ADJ	Output Voltage Adjustment	Allows adjustment within ±10%. Turning clockwise increases the output voltage. Turning counterclockwise decreases the output voltage.
DC ON	Operation Indicator (green)	Illuminates when the output voltage is on.

## DIMENSIONS (mm)

### PS5R-VB/VC

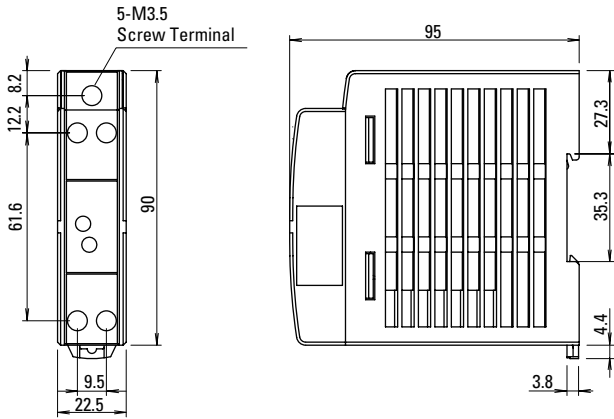

### PS5R-VD

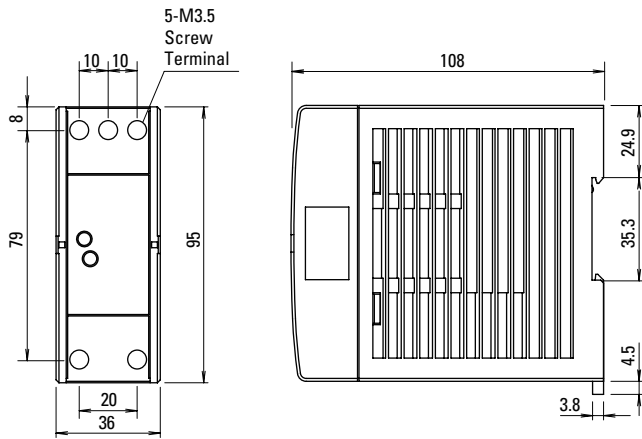

### PS5R-VF

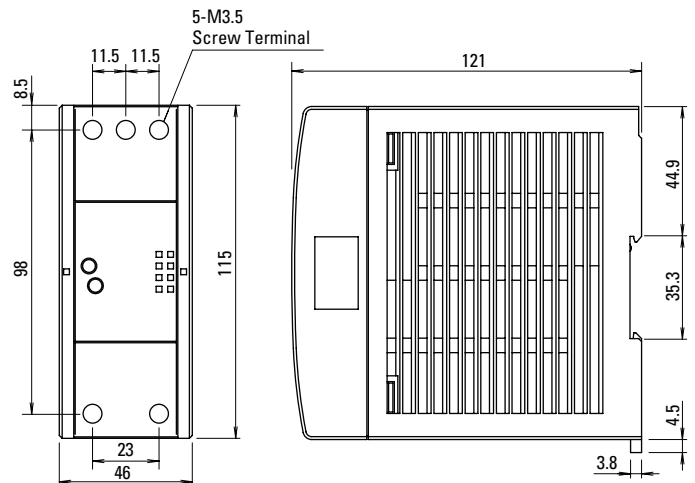

## ACCESSORY PART NUMBERS

### Panel Mounting Bracket\*2

Applicable Switching Power Supply	Part Number	Remarks
PS5R-VB	PS9Z-5R1B	—
PS5R-VC	PS9Z-5R2B	For side mounting
PS5R-VD	PS9Z-5R1C	—
PS5R-VF	PS9Z-5R1E	—

\*2: Used when installing on a panel directly.

### DIN Rail (35mm-wide)

Length	Part Number	Material
1000mm	BNDN1000	Aluminum

### End Clip

Part Number
BNL6
BNL8

### PS9Z-5R2B

#### Side-mount - Panel Mounting Bracket

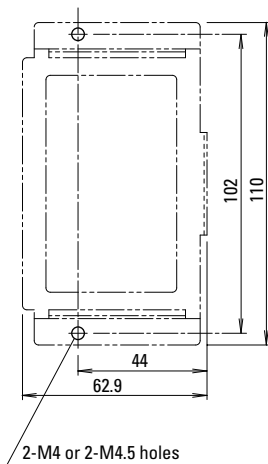

### PS9Z-5R1B

#### Panel Mounting Bracket

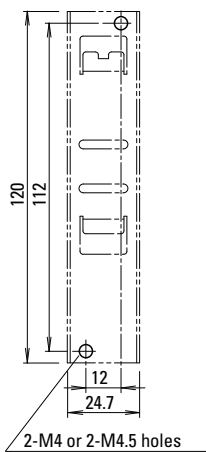

### PS9Z-5R1C Panel Mounting Bracket

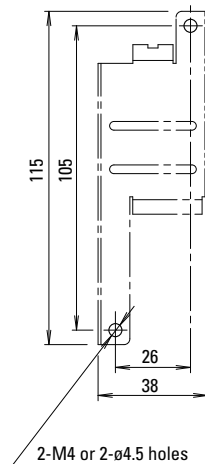

### PS9Z-5R1E Panel Mounting Bracket

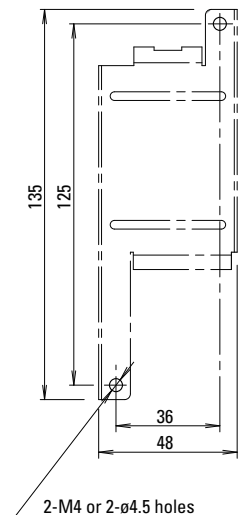

## MTBF\*

PS5R-VB: 900,000H minimum

PS5R-VC: 650,000H minimum

PS5R-VD: 450,000H minimum

PS5R-VF: 350,000H minimum

MIL-HDBK-217FN2

\*MTBF stands for Mean Time Between Failure, which is calculated according to statistical device failures, and indicates reliability of a device. It is the statistical representation of the likelihood of the unit to fail and does not necessarily represent the expected life of a product.

## SAFETY PRECAUTIONS

The PS5R-V should be placed in a proper enclosure. It is designed to be used with general electrical equipment and industrial electric devices.

- Do not use switching power supplies with electric equipment whose malfunction or inadvertent operation may damage the human body or life directly.
- Make sure that the input voltage and output current do not exceed the ratings. If the input voltage and output current exceed the ratings, electric shock, fire, or malfunction may occur.
- Do not touch the terminals of the switching power supply while input voltage is applied, otherwise electric shock may occur.
- Provide the final product with protection against malfunction or damage that may be caused by malfunction of the switching power supply.
- Operating temperatures should not exceed the ratings. Be sure to note the derating characteristics. If the operating temperature exceeds the ratings, electric shock, fire, or malfunction may occur.

## OPERATING INSTRUCTIONS

### Notes for installation

- Do not close the top or bottom openings of the PS5R-V to allow for heat radiation by convection.
- When mounting multiple PS5R-V switching power supplies side by side, maintain a minimum of 10 mm clearance. Observe the derating curves in consideration of the ambient temperature.

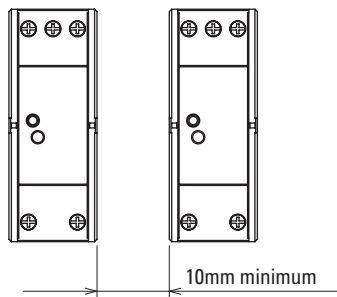

- When the derating voltage may exceed the recommended value, provide forced air-cooling.
- Make sure to wire the ground terminal correctly.
- For wiring, use wires of heat resistance of 60°C or higher (PS5R-VB: 80°C or higher). Use copper wire of the following sizes, according to the rated current.
- Recommended wire size: AWG18 to 14

Note: Wires of the above size must be used to comply with UL508, CSA C22.2 No. 107.1.

### Applicable crimp terminal (reference)

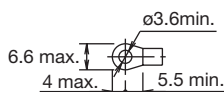

- Recommended tightening torque of the input and output terminals is 1.0 to 1.3N·m (0.8N·m for UL).

- Blown fuses indicate that the internal circuits are damaged. Contact IDEC for repair. Do not just replace the fuse and reoperate, otherwise electric shock, fire, or malfunction may occur.
- Do not use the switching power supplies to charge rechargeable batteries.
- Do not overload or short-circuit the switching power supply for a long period of time, otherwise the internal elements may be damaged.
- Do not disassemble, repair, or modify the power supplies, otherwise the high voltage internal part may cause electric shock, fire, or malfunction.
- The fuse inside the PS5R-V switching power supply is for AC input. Use an external fuse for DC input.

### Mounting on DIN Rails

- Use a 35mm-wide DIN rail.
- Place the PS5R-V on the DIN rail as shown with input terminal side up (①), and press the PS5R-V towards the DIN rail (②). Make sure that the PS5R-V is installed firmly.
- Use BNL6 end clips to ensure power supplies do not slide off the end of the DIN rail. Use of BNL8 end clips is recommended when excessive vibration or shock is anticipated.

### Removal

- Insert a flat screwdriver into the slot in the clamp, and pull out until it clicks (③). The lock mechanism is released and the PS5R-V can be removed (④). When mounting the PS5R-V again, push in the latch first.

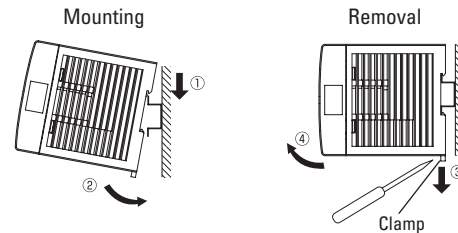

# OPERATING INSTRUCTIONS

## Installing a Panel Mounting Bracket

### <Installing PS9Z-5R1□ Panel Mounting Bracket>

#### Panel Mounting Bracket (PS9Z-5R1□)

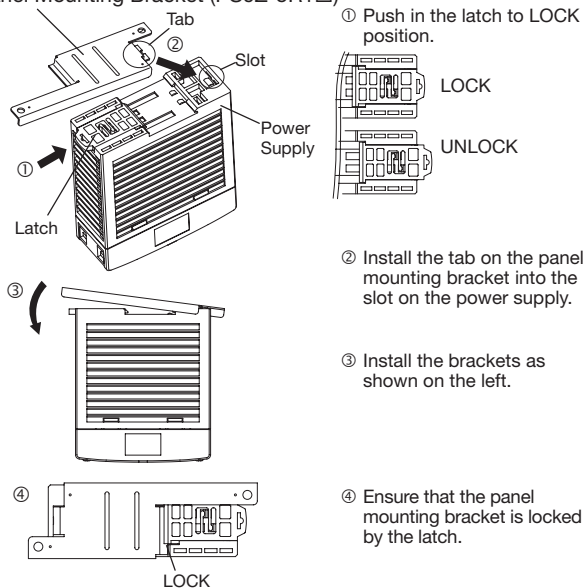

### <Installing PS9Z-5R2B Panel Mounting Bracket>

#### Panel Mounting Bracket (PS9Z-5R2B)

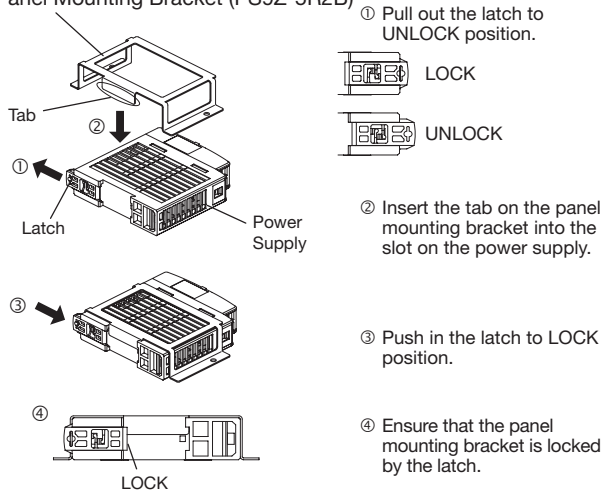

## Adjustment of Output Voltage

The output voltage can be adjusted within  $\pm 10\%$  of the rated output voltage by using the VR.ADJ control on the front. Turning the VR.ADJ clockwise increases the output voltage. Turning the VR.ADJ counterclockwise decreases the output voltage.

## Overcurrent Protection

The output voltage drops automatically when an overcurrent flows due to an overload or short circuit. Normal voltage is automatically restored when the load returns to normal conditions.

## Notes for Operation

- Output interruption may indicate blown fuses. Contact IDEC.
- The PS5R-V switching power supply contains an internal fuse for AC input. When using DC input, install an external fuse. To avoid blown fuses, select a fuse in consideration of the rated current of the internal fuse.

## Rated Current of Internal Fuses

Part Number	Internal Fuse Rated Current
PS5R-VB/VC	2A
PS5R-VD/VF	4A

- Avoid overload and short-circuit for a long period of time, otherwise the internal elements may be damaged.
- DC input operation is not subject to safety standards.

## Rust and Scratches on Metal parts

Bonded metal parts are used for the PS5R-V. Rust on the edge and scratches on the surfaces may be developed depending on the storage condition, but the performance of the PS5R-V is not affected.

## Noise

Small acoustic noise inside the PS5R-V may be heard depending on the input voltage and load, but the performance of the PS5R-V is not affected.

## OPERATING INSTRUCTIONS

### Series Operation

Series operation is allowed. Connect Schottky barrier diodes D as shown below. Select a Schottky diode in consideration of the rated current. The diode's reverse voltage must be higher than the PS5R-V's output voltage.

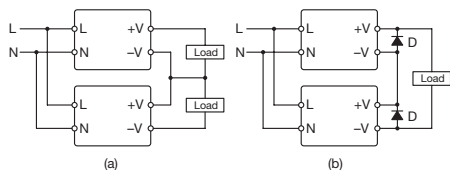

### Parallel Operation

**Parallel operation is not possible to increase the output capacity, because the internal elements and load may be damaged.**

## WARRANTY

### Warranty

IDEC warrants the PS5R-V switching power supply for a period of five years from the date of shipment.

### Scope

IDEC agrees to repair or replace the PS5R-V switching power supply if the product has been operated under the following conditions. The maximum value of output capacity is within the range shown in "Operating Temperature vs. Output Current" on page 3.

1. Average operating temperature (ambient temperature of switching power supply) is 40°C maximum.
2. The load is 80% maximum.
3. Input voltage is the rated input voltage.
4. Standard mounting style

### Backup Operation

Backup operation is a connection method of two switching power supplies in parallel for emergency. Normally one switching power supply has a sufficient output. If one switching power supply fails, another one operates to continue the output. Make sure that the sum of power consumption by load and diode is not greater than the rated wattage (rated voltage × rated current) of one switching power supply.

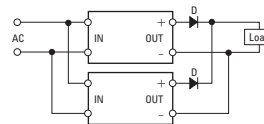

Select a diode in consideration of:

Diode's current must be more than double the PS5R-V's output current. Take heat dissipation into consideration.

IDEC shall not be liable for other damages including consequential, contingent or incidental damages. Warranty does not apply if the PS5R-V switching power supply was subject to:

1. Inappropriate handling, or operation beyond specifications.
2. Modification or repair by other than IDEC.
3. Failure caused by other than the PS5R-V switching power supply.
4. Failure caused by natural disasters.

