

SENTROL

2100 SERIES

Installation Instructions

**Models: 2105, 2105-A, 2107, 2107-A, 2107-AH,
2115, 2115-A, 2117, 2117-A, 2117-AH**

INSTALLATION

Models: 2105, 2105-A, 2107, 2107-A, 2117-AH

Mount the magnet section on the object to be protected, which would be removed in case of theft. Once installed, place the cover over the magnet and screw to surface. Use #10 screws to secure both units. Mount the cord section with clamps so the cord will pull straight out of the magnet housing when it reaches the end of the cord. Also make sure it has the correct slack and loop so it will not hang up on anything as the protected object is moved.

Alternate mounting:

Loop the cord through the item being protected or through a stationary object.

Caution-

If these methods are used, make sure that alarm owner is warned that he could break the pull-apart if he didn't release it before moving protected item.

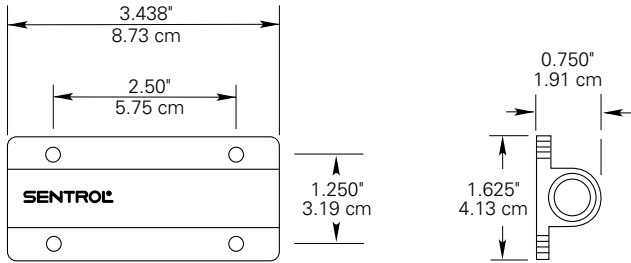

2105 Magnetic Cover

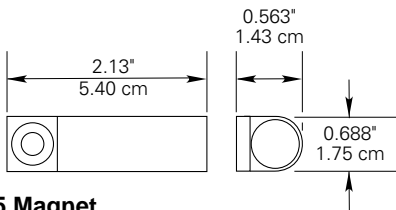

2105 Magnet

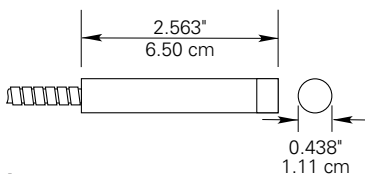

Switch

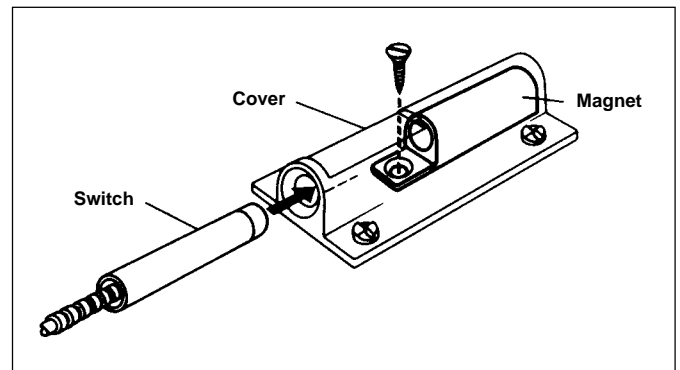
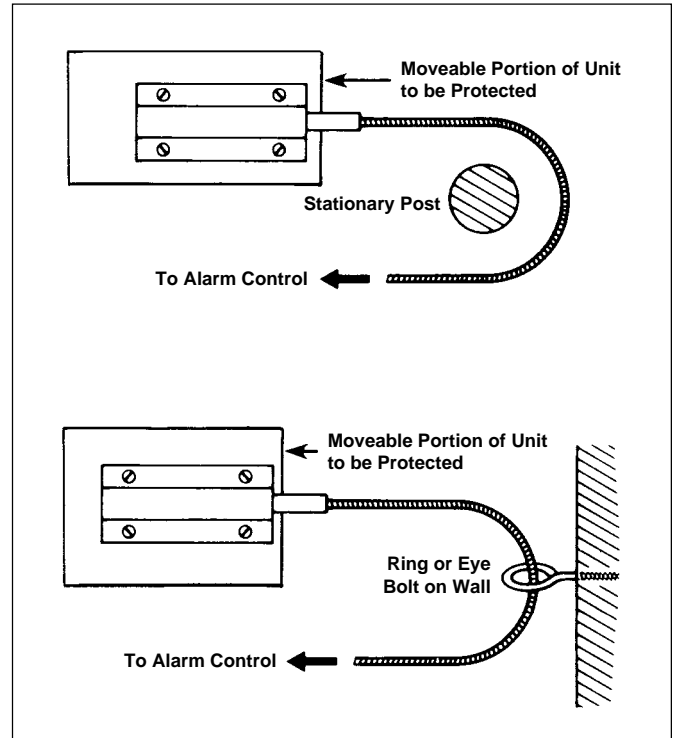

Models: 2105, 2105-A, 2107, 2107-A, 2117-AH

INSTALLATION CONT.

MODELS: 2115, 2115-A, 2117, 2117-A, 2117-AH

Drill a 3/4" diameter x 3 1/2" deep hole in the movable portion of the unit being protected (boat, truck, trailer, equipment). Also drill 3/16" diameter holes for mounting screws. Install the magnet portion in the 3/4" diameter hole and mount with two number 8 flat head screws. If concern exists that magnet housing will be removed, thread a 3/4-10 nut onto the housing. The use of high-security (tamper proof) screws is another option.

Mount the cord section with clamps so the cord will pull straight out of the magnet housing when it reaches the end of the cord. It is also important to make sure the cord has the correct slack and loop so it will not hang up on anything as the protected object is moved.

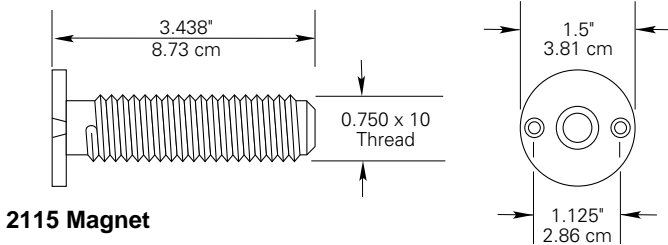

2115 Magnet

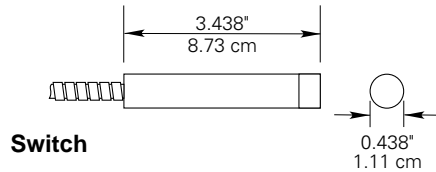

Switch

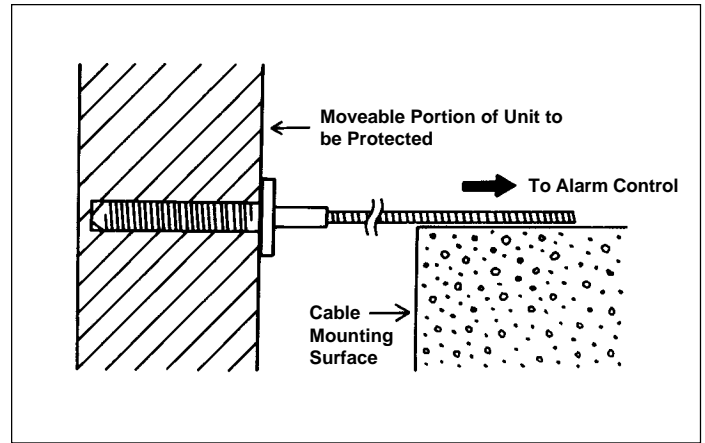

LEAD FUNCTIONS

Form A Models (2105, 2105-A, 2115, 2115-A) use black leads.

Form C Models (2107, 2107-A, 2107-AH, 2117, 2117-A, 2117-AH)

Lead Color	Function
Black	Common
White	Closed Loop (N.O.)
Red	Open Loop (N.C.)

ORDERING INFORMATION

Part Number	Loop Type	Electrical Configuration	Color Choices	Lead Type
2105	Closed	N.O.	Off-white, grey or mahogany brown	3 ft. vinyl jacketed
2105-A	Closed	N.O.	Off-white, grey or mahogany brown	3 ft. stainless steel armored cable
2107	Open or Closed	SPDT	Off-white, grey or mahogany brown	3 ft. vinyl jacketed
2107-A	Open or Closed	SPDT	Off-white, grey or mahogany brown	3 ft. stainless steel armored cable
2107-AH	Open or Closed	SPDT	Off-white, grey or mahogany brown	3 ft. stainless steel armored cable
2115	Closed	N.O.	Off-white, grey or mahogany brown	3 ft. vinyl jacketed
2115-A	Closed	N.O.	Off-white, grey or mahogany brown	3 ft. stainless steel armored cable
2117	Open or Closed	SPDT	Off-white, grey or mahogany brown	3 ft. vinyl jacketed
2117-A	Open or Closed	SPDT	Off-white, grey or mahogany brown	3 ft. stainless steel armored cable
2117-AH	Open or Closed	SPDT	Off-white, grey or mahogany brown	3 ft. stainless steel armored cable

** **Form A:** (2205, 2105-A, 2115, 2115-A)

Voltage: 100 V AC/DC MAX.

Current: 0.5 A MAX.

Power: 7.5 W MAX.

Form C: (2107, 2107-A, 2107-AH, 2117, 2117-A, 2117-AH)

Voltage: 100 V AC/DC MAX.

Current: 0.3 A MAX.

Power: 3.0 W MAX.

** European Union Specifications; 48 V AC/DC Max., 0.5 Amp

* Other lead types available; please inquire.

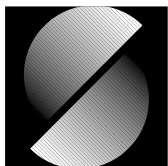

SENTROL

Phone: 800.894.0412 - Fax: 888.723.4773 - Web: www.clwtr.com - Email: info@clwtr.com