

LED Series Sealed Backlights

For use with any Vision system



- Rugged, waterproof housing, rated IEC IP67
- Mounts directly from the back or surface mount using available brackets
- Smooth exterior for easy cleaning
- Diffused backlights for any Vision system. See Banner's web site for a complete lighting tutorial
- Continuous or strobed operation is selectable via sensor software.
- Solid-state LED matrix, in four sizes
- Available in four visible colors plus infrared
- Extremely bright light
- Completely non-corrosive
- Extremely even intensity edge-to-edge
- M12 connector

Models

Models	LED Color	Wavelength	Lighted Area
LEDIB75X150PW2-XQ	Infrared	850 nm	75 x 150 mm (2.95" x 5.91")
LEDRB75X150PW2-XQ	Visible Red	633 nm	
LEDBB75X150PW2-XQ	Blue	469 nm	
LEDGB75X150PW2-XQ	Green	525 nm	
LEDWB75X150PW2-XQ	White	6500 k	
LEDIB150X150PW2-XQ	Infrared	850 nm	150 x 150 mm (5.91" x 5.91")
LEDRB150X150PW2-XQ	Visible Red	633 nm	
LEDBB150X150PW2-XQ	Blue	469 nm	
LEDGB150X150PW2-XQ	Green	525 nm	
LEDWB150X150PW2-XQ	White	6500 k	
LEDIB225X150PW2-XQ	Infrared	850 nm	225 x 150 mm (8.86" x 5.91")
LEDRB225X150PW2-XQ	Visible Red	633 nm	
LEDBB225X150PW2-XQ	Blue	469 nm	
LEDGB225X150PW2-XQ	Green	525 nm	
LEDWB225X150PW2-XQ	White	6500 k	
LEDIB300X150PW2-XQ	Infrared	850 nm	300 x 150 mm (11.81" x 5.91")
LEDRB300X150PW2-XQ	Visible Red	633 nm	
LEDBB300X150PW2-XQ	Blue	469 nm	
LEDGB300X150PW2-XQ	Green	525 nm	
LEDWB300X150PW2-XQ	White	6500 k	

Specifications

Light Source

LED; wavelengths:

LED Color	Wavelength
Infrared	850 nm
Visible Red	633 nm
Blue	469 nm
Green	525 nm
White	6500 k

Supply Voltage and Current

75x150 mm models: 24V dc \pm 10% @ 550 mA max.

150x150 mm models: 24V dc \pm 10% @ 1.1 A max.

225x150 mm models: 24V dc \pm 10% @ 1.65 A max.

300x150 mm models: 24V dc \pm 10% @ 2.2 A max.

Connections

5-pin Euro style (MIL) M12 male connector; accessory cable required for operation

Operating Conditions

Temperature: 0° to +50°C (+32° to 122°F)

Relative Humidity: 95% max relative, non-condensing

Illumination

Diffused for use in applications needing a backlit light source

Useful Life

B50/L50 Lifetime > 100,000 hours (Infrared, Red)

B50/L50 Lifetime > 90,000 hours (Blue, Green, White)

Construction

Black Valox™ housing; acrylic window

Environmental Rating

IEC IP67

Dimensions

LED Series Sealed Backlights

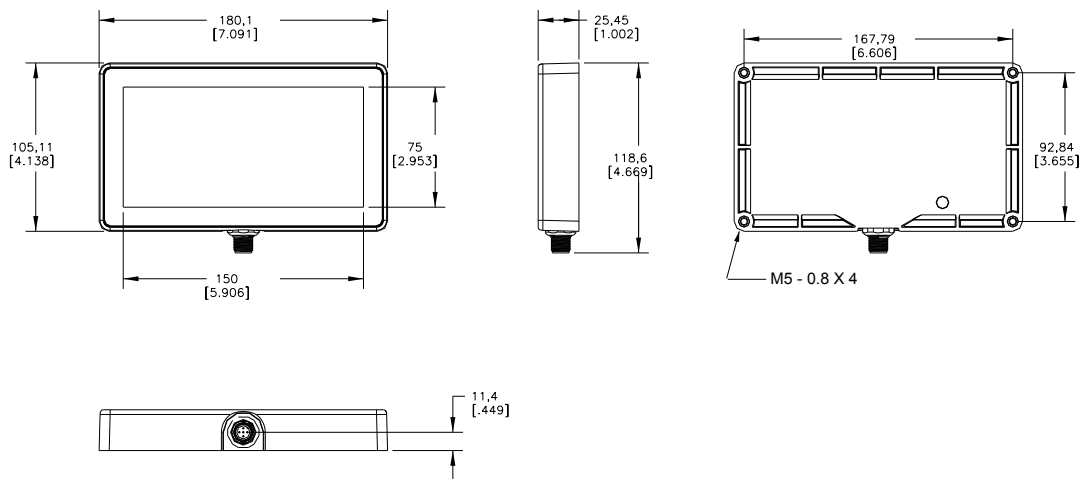

LED Series Sealed Backlights

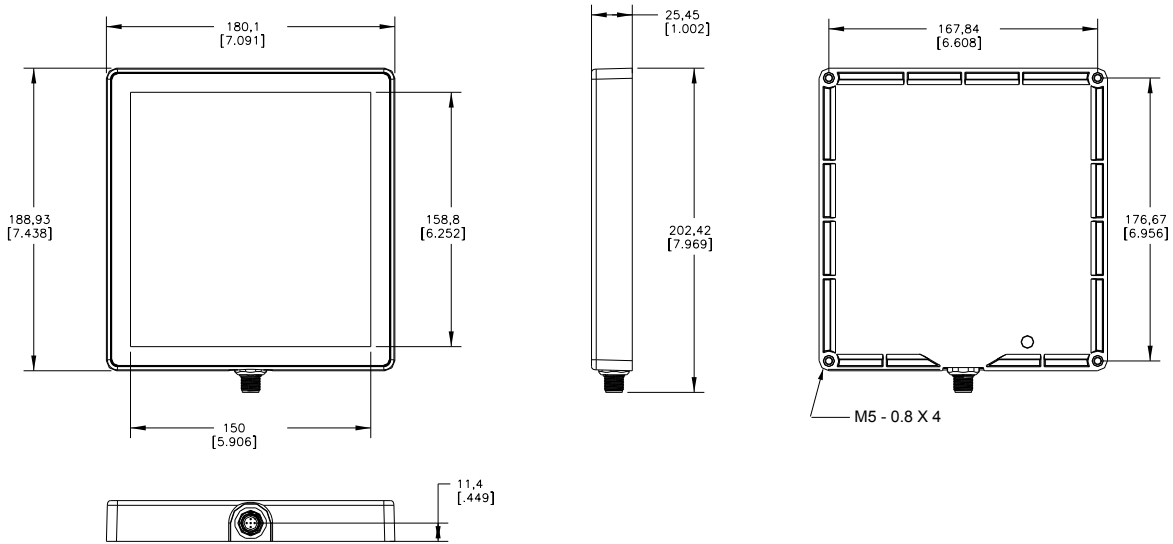

LED Series Sealed Backlights

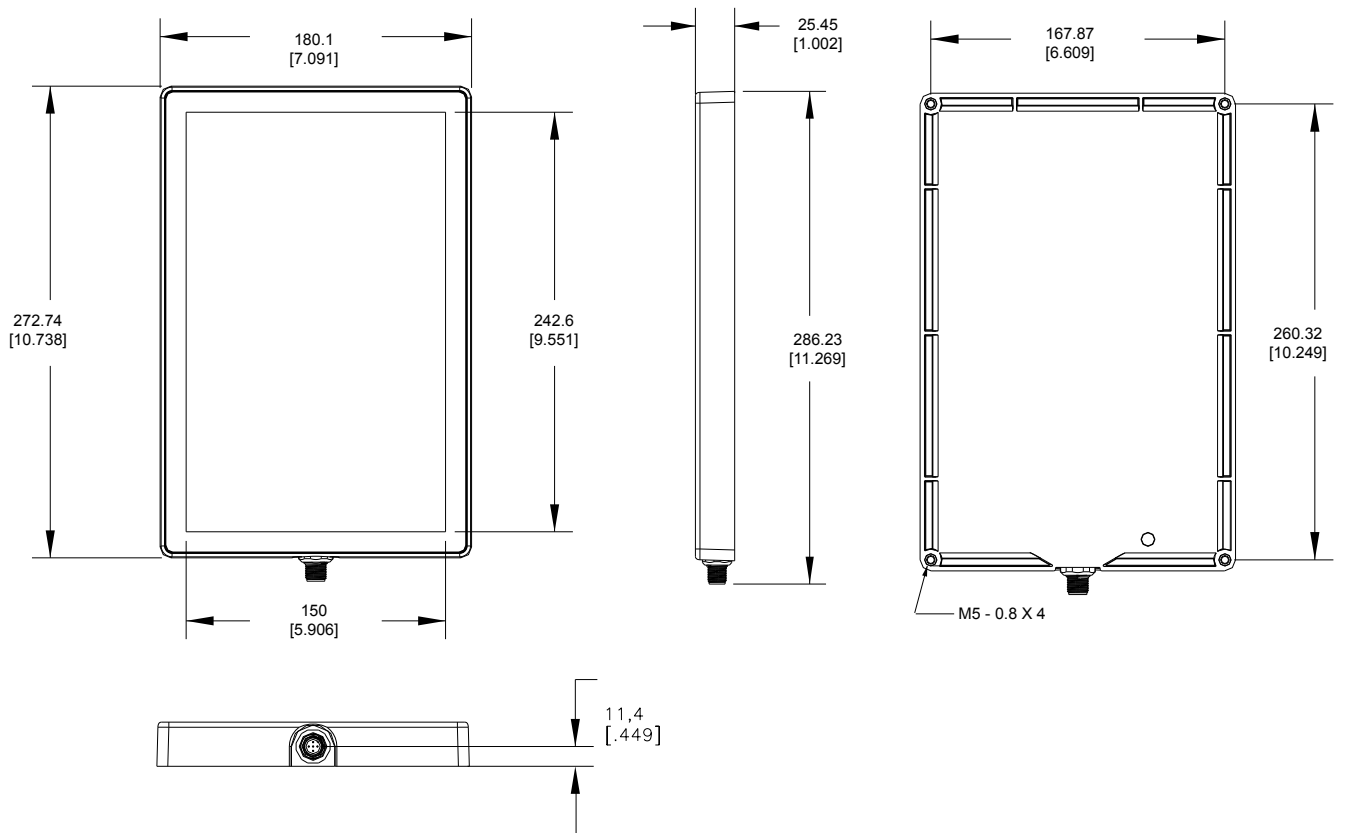

LED Series Sealed Backlights

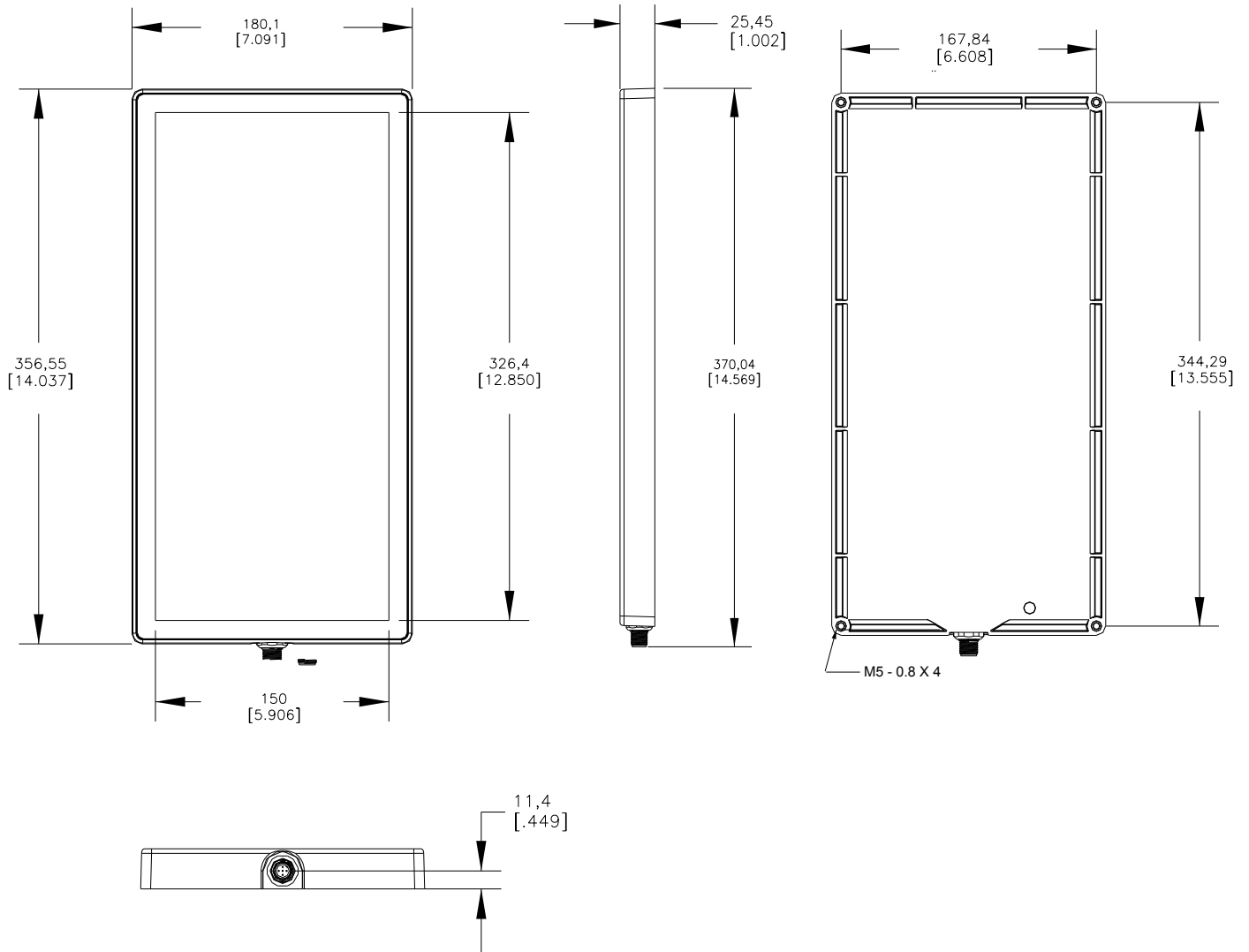

Wiring Table

Wire Purpose	Cable Wire Color*	Continuous On Mode	Strobed Mode	PresencePlus Pro Controller Terminal Block
Power Wires	Brown (1)	+24V dc	+24V dc	Pin 01 **
	Blue (3)	common	common	Pin 02
Strobe Polarity Control	Gray (5)	open	Active Low: open	Open — Active Low
			Active High: connect to common (Blue wire)	Pin 02 — Active High
Strobe Voltage Wires	White (2)	open	0V dc = ON (Active Low) +5 to 24V dc = OFF (Active Low)	Pin 04
			0V dc = OFF (Active High) +5 to 24V dc = ON (Active High)	
	Black (4)	open	Strobe common	Pin 02

Figure 1. Pinouts for Mating Cable

* For Banner-supplied wire.

** When connecting the light to a PresencePLUS Pro controller terminal block, the controller supply must be 24V dc \pm 10%.

Cordsets

For use with nickel-plated aluminum housing:	For use with stainless steel housing:
<p>5-Pin Quick-Disconnect (QD) Cordsets</p> <p>5-wire cable, straight female Euro-style (M12) connector (nickel-plated brass coupling nut) at one end, with flying leads at opposite end.</p> <p>MQDC20-506, 2 m (6')</p> <p>MQDC20-515, 5 m (15')</p> <p>MQDC20-530, 9 m (30')</p>	<p>5-Pin Quick-Disconnect (QD) Cordsets</p> <p>5-wire cable, straight female Euro-style (M12) connector (stainless steel coupling nut) at one end, with flying leads at opposite end.</p> <p>MQDC20SS-506, 2 m (6')</p> <p>MQDC20SS-515, 5 m (15')</p> <p>MQDC20SS-530, 9 m (30')</p>

Accessory Brackets

Part Number	Description	Bracket
SMBBSSM	All brackets and hardware are 100% 316 stainless steel	 <p data-bbox="748 577 834 604">Includes:</p> <ul data-bbox="769 621 1365 688" style="list-style-type: none"><li data-bbox="769 621 886 648">• 2 Brackets<li data-bbox="769 655 1365 688">• 4 M5 - 0.8 stainless steel screws (socket drive, button head)